

## Electropneumatic Positioning System with an Adaptive Force Controller

A. Grigaitis, V. A. Geleževičius

Department of Control Technology, Kaunas University of Technology,

Studentų str. 48, LT-51367 Kaunas, Lithuania, phone: +370 37 300339, e-mail: vilius.gelezevicius@ktu.lt

### Introduction

An experience obtained on the area of design of electromechanical position control systems declares an efficiency of the multiloop hierarchical control mode application for this purpose. The following control method requires a separate controller for each state variable such as a force, a velocity and a position regulation. The good controllability of the state variables of the system and a possibility to adjust independently the used controllers is the essential advantage of the method [1].

When developing an electropneumatic position control system with pneumatic cylinder, playing the role of actuator of the system, the highly expressed nonlinearity of force generation process is to be considered. As it is shown in [2] the dynamical behaviour of pneumatic cylinder highly depends of initial position of piston and of starting pressures in working chambers of the cylinder.

The presented force control method of a pneumatic cylinder with adaptive force controller [3] gives an excellent efficiency and ensures an invariance of force behaviour on initial control conditions defined by initial piston position and initial pressure in working chambers of pneumatic cylinder.

On the base of adaptive force control system the electropneumatic position control system enabling velocity and position of a cylinder piston rod controlling can be developed. The strategy of design of velocity and position controllers of electropneumatic positioning system is presented in this paper.

### Development of position control system of pneumatic cylinder with an adaptive force controller

The structure of multiloop electropneumatic position control system with an adaptive force controller is presented in Fig. 1. The force, velocity and position controllers are denoted as  $H_S$ ,  $H_V$  and  $H_P$  accordingly. The force, velocity and position transfer coefficients are designated as  $k_F$ ,  $k_S$  and  $k_P$ . The  $H_R$  and  $k_R$  are transfer

function and transfer coefficient of the reference model of an adaptive force controller.  $H_V$  is the transfer function of the electropneumatic directional control valve.

The force controller corresponds to the quantitative optimum condition [1] and has the transfer function:

$$H_F(p) = \frac{T_c^* p + 1}{2k_v k_c^* k_F T_v p}, \quad (1)$$

where  $T_c^*$  – time constant defining average inertness of force generating process of pneumatic cylinder [3],  $T_v$  – time constant of the proportional directional control valve;  $k_c^* = \frac{\Delta p}{A_v}$ ,  $A_v$  – orifice area of the valve,  $m^2$ ,  $k_v$  – transfer coefficient of the valve.

Supposing the quality of adjusted in such way force control contour as desirable, the transfer function of reference model for adaptive force controller has been defined as:

$$H_R(p) = \frac{1}{2T_{\mu F}^2 p^2 + 2T_{\mu F} p + 1}, \quad (2)$$

where  $T_{\mu F}$  – the time constant of force control contour, approximately equal to  $T_v = 0.05s$ .

Results of investigation of the electropneumatic force control system with adaptive force controller are presented in the paper [3]. Modelling of force controller with adaptive force controller has been carried out with means of software *Matlab Simulink*. Dynamic behavior of force control loop is presented Fig. 2. There the dynamical response curves of the force developed by a pneumatic cylinder provoked by step mode reference signal are presented. Each curve is obtained for different initial conditions.

These initial conditions are expressed as different starting positions of the piston and different initials pressures in working chambers of the cylinders.

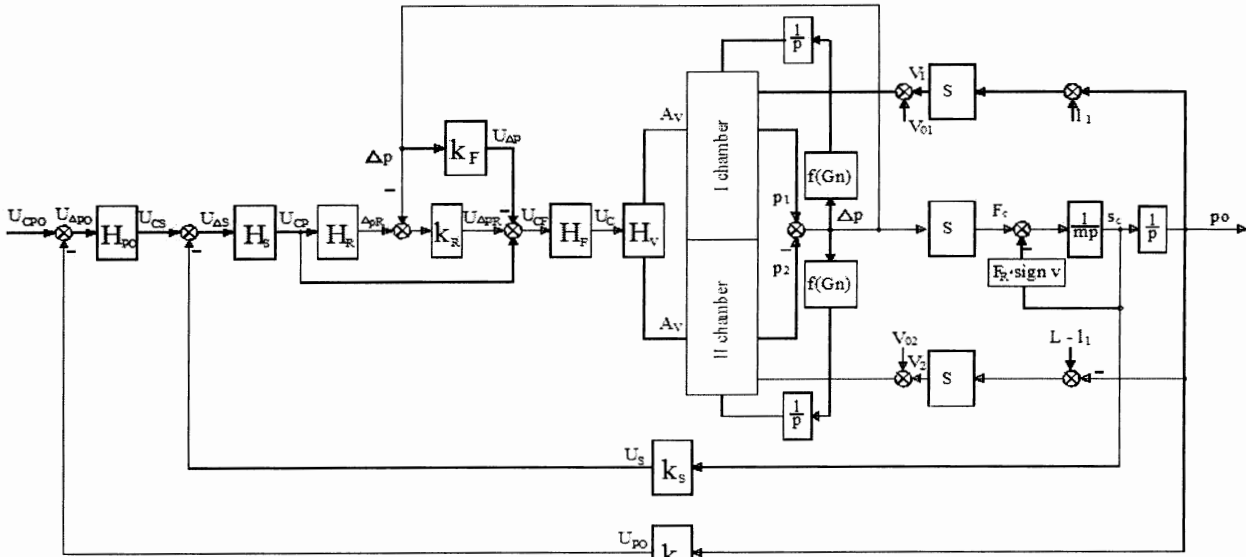

Fig. 1. The structural model of an electropneumatic position control system

As it is shown in Fig. 2, the response curves obtained under the several initial conditions are coincident and closely correspond to the response curve of the reference model.

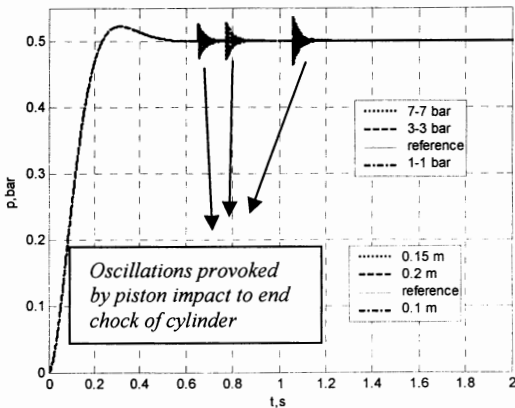

Fig. 2. Dynamical behavior of the force control process on different initial conditions

Limitations on the length of the cylinder clearly manifest they self by oscillations provoked by impacts of the piston to the end cup of the cylinder.

### Design of velocity controller of an electropneumatic position control system

Development of higher hierarchy level controllers of pneumatic servo system such as velocity controller of pneumatic cylinder can be carried out using well known hierarchical system design methods based on quantitative optimum condition fulfilling. Supposing the adaptive force control system being well functioning, the transfer function of the whole force control contour can be taken equal to the transfer function of the reference model  $H_{FC}(p) \cong H_R(p)$  [3]. After approximation of this function to the function of

the first order, the transfer function of the force regulation system can be expressed as:

$$H_{FC}(p) = \frac{1}{2T_{\mu F}p + 1} \quad (3)$$

Functional diagram of velocity control system of an electropneumatic servo system with adaptive force controller is presented in Fig 3.

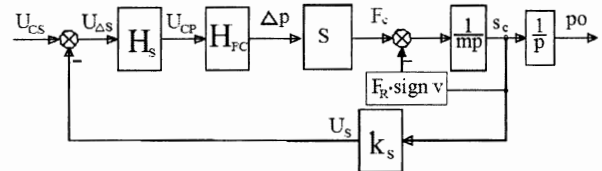

Fig. 3. Functional diagram of a the velocity control system with an adaptive force controller

According quantitative optimum condition [1] the transfer function of a velocity controller of electropneumatic drive can be drawn out from the condition:

$$H_S(p) \cdot H_{PC}(p) \cdot S \cdot \frac{1}{mp} \cdot k_S = \frac{1}{2T_{\mu S}p(T_{\mu S}p + 1)} \quad (4)$$

where  $m$  – mass of the moving part, kg;  $S$ – surface area of the piston,  $m^2$ ;  $T_{\mu S}$  - time constant, s.

Supposing the  $T_{\mu S}$  being equal to  $2T_V = 0.1s$  and  $H_{FC}(p) \cong \frac{k_R}{2T_{\mu F}p + 1}$ ; a simple proportional velocity controller is designed :

$$H_S(p) = \frac{m}{4k_R \cdot k_S \cdot S \cdot T_{\mu}} \quad (5)$$

Modelling results of velocity control system of pneumatic cylinder with adaptive force controller are presented in Fig. 4. The velocity reaction curves

demonstrate an invariance of velocity transient regime on changing control conditions.

After the piston of the cylinder has reached end position it suddenly stops. Stop time depends on starting position of the piston of the cylinder.

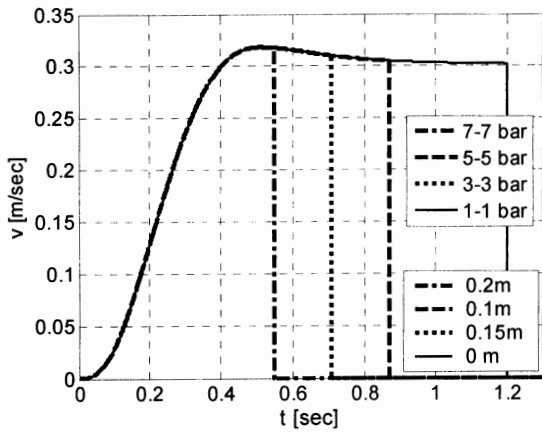

**Fig. 4.** Velocity response curves of cylinder being in several initial start positions and with different initial pressures in the working chambers. Vertical lines indicate stop of the piston in the end position

#### Development of position controller of the electropneumatic position control system

Position controller of the system has been designed by following the same the quantitative optimum condition:

$$H_P(p) \cdot H_S(p) \cdot \frac{1}{p} \cdot k_p = \frac{1}{2T_{\mu p}(T_{\mu p}p + 1)} \quad (6)$$

Supposing the  $T_{\mu p}$  being equal to  $4T_V$  and  $H_S(p) \cong \frac{1/k_s}{4T_R p + 1}$ , position controllers will be:

$$H_P(p) = \frac{k_s}{8T_R \cdot k_p} \quad (7)$$

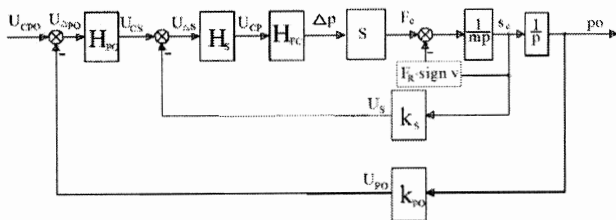
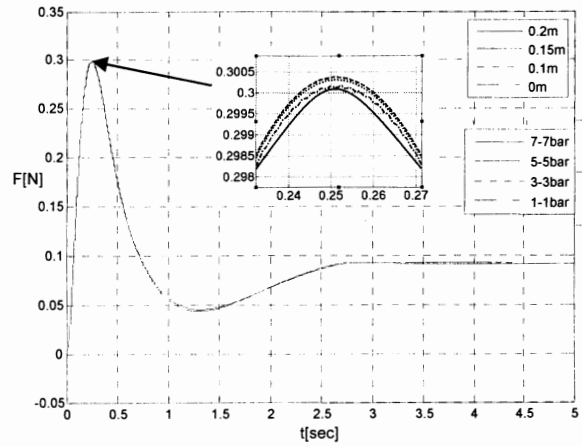

**Fig. 5.** Functional diagram of multiloop electropneumatic position control system with adaptive force controller

Investigation of electropneumatic position control system with adaptive force controller has been carried out won the base of rodless pneumatic cylinder with piston diameter of 25 mm and stroke of 300 mm and proportional directional control valve MPYE-5-1/8.

Dynamical behaviour of the multiloop electropneumatic position control has been investigated on following initial conditions:

1. The piston of the 0.3 m length cylinder was in different starting positions equal to 0 m, 0.1 m, 0.15 m and 0.2 m, and initial absolute pressure of working chambers was equal to 7 bars. Modelling results are presented in Fig. 6, 7, 9.
2. The piston of the 0.3 m length cylinder was in middle position and initial absolute pressures of working chambers was equal to 1, 3, 5 and 7 bars. Modelling results are presented in Fig. 6, 7, 8.



**Fig. 6.** Response curves of the piston force the piston being in several starting positions and with different initial pressures in working chambers of the cylinder

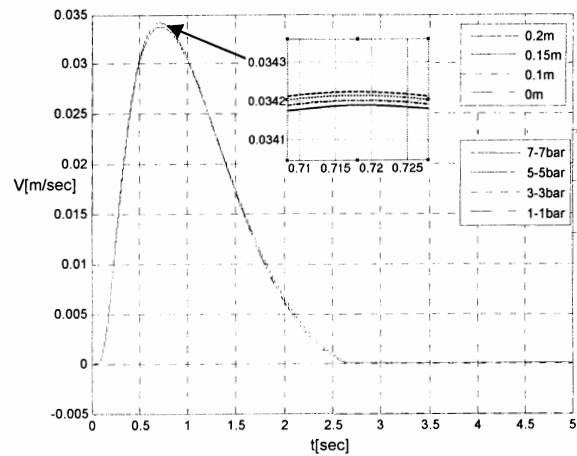

**Fig. 7.** Response curves of the piston velocity the piston being in several starting piston positions and with different initial pressures in working chambers of the cylinder

The dynamical regime force and velocity curves of electropneumatic position control system with adaptive force regulator confirm an efficiency of proposed method, ensuring an independence of dynamical quality on either the starting position of the piston or initial pressure in working chambers of the cylinder change. This allows do not take in account of these circumstances when position controller is designed.

Investigation results given in Fig. 6, 7 and 8 confirm correctness of this assumption. The response curves of force, velocity and position of electropneumatic position control system provoked by the step mode position

reference signal are identical for several starting conditions of the system.

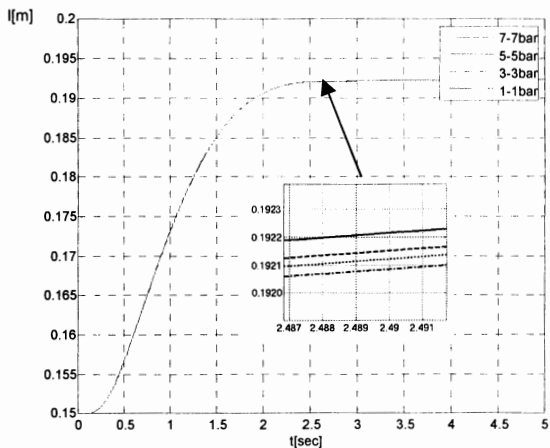

Fig. 8. Response curves of the piston position when initial pressure in cylinder chambers was 1, 3, 5 and 7 bar

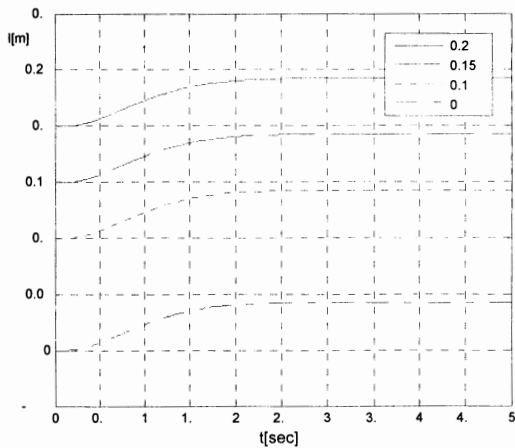

Fig. 9. Response curves of the piston position when piston is in different starting conditions

The position responses presented in Fig. 9 clearly indicates uniformity of reaction of electropneumatic position control system performing preset displacement,

the piston of the cylinder having the 0.35 m stroke and being in several initial positions equal to 0, 0.1, 0.15 and 0.2 m.

## Conclusions

1. The electropneumatic position control system with an adaptive force regulator has been developed and investigated in this paper. Reference model based signal adaptive control method has been applied for force regulation of the position control system.
2. Application of adaptive force regulator allow eliminating of influence of initial starting position of pneumatic cylinder such as initial position of piston and initial pressures in working chambers of the cylinder on control quality of force, velocity and position of the system.
3. Modelling results confirm an efficiency of presented control method. The method is especially suitable because an essential nonlinearities of electropneumatic control system manifest they self in the force generation stage of the system

## References

1. **Geleževičius V.** Elektros pavarų valdymo sistemos. – Vilnius: Mokslas, 1990. – 360 p.
2. **Grigaitis A., Geleževičius V. A.** Development of Electropneumatic Servo System with Reference Model Based Signal Adaptive Force Controller // Journal of Vibroengineering. – Vilnius: Vibromechanika, 2007. –No. 4. – P. 45–50.
3. **Geleževičius V. A, Grigaitis A.** Research of Adaptive Force Control Loop of Electropneumatic Acting System // Electronics and Electrical Engineering. – Kaunas: Technologija, 2007. – No. 7(79). – P. 7–10.

Received 2008 03 12

**A. Grigaitis, V. A. Geleževičius. Electropneumatic Positioning System with an Adaptive Force Controller // Electronics and Electrical Engineering. – Kaunas: Technologija, 2008. – No. 7(87). – P. 3–6.**

Electropneumatic servo drive with reference model based signal adaptive force controller is investigated. The strategies of design of the further drive controllers such as velocity and position ones are presented. The investigation results of the electropneumatic servo drive on changing initial working conditions are presented and discussed in the paper. Il. 9, bibl. 3. (in English; summaries in English, Russian and Lithuanian).

**A. Григайтис, В. А. Геляжвявичус. Электропневматическая система позиционирования с адаптивным регулятором силы // Электроника и электротехника. – Каунас: Технология, 2008. – № 7(87). – С. 3–6.**

Исследуется модель электропневматической исполнительной системы с адаптивным контуром регулирования силы. Описана методика настройки регуляторов и выбора эталонной модели. Проведены исследования при изменяющемся начальном давлении в камерах цилиндра и начальном положении поршня. Ил. 9, библ. 3 (на английском языке; рефераты на английском, русском и литовском яз.).

**A. Grigaitis, V. A. Geleževičius. Elektropneumatinė pozicionavimo sistema su adaptyviu jėgos reguliatoriumi // Elektronika ir elektrotechnika. – Kaunas: Technologija, 2008. – Nr. 7(87). – P. 3–6.**

Pateiktas ir išnagrinėtas elektropneumatinės vykdomo sistemos modelis su adaptyviu jėgos reguliavimo kontūru. Aprašyta greičio ir padėties reguliatorių parinkimo metodika. Atlikti tyrimai keičiant pradinį darbo kamerų slėgį ir pradinę stūmoklio padėtį. Pateikti ir aptarti tyrimo rezultatai. Il. 9, bibl. 3 (anglų kalba; santraukos anglų, rusų ir lietuvių k.).