

# Electromagnetic Thimble for Blind: Design and Investigation

R. Bansevicius<sup>1</sup>, V. Jurenas<sup>1</sup>, D. Mazeika<sup>1</sup>, A. Zvironas<sup>1</sup>, J. A. Virbalis<sup>2</sup>

<sup>1</sup>*Mechatronics Center for Research, Studies and Information, Kaunas University of Technology, Kestucio St. 27, LT-44025, Kaunas, Lithuania*

<sup>2</sup>*Department of Electrical Engineering, Kaunas University of Technology, Studentu St. 48–241, LT-51367 Kaunas, Lithuania*  
 arvydas.virbalis@ktu.lt

**Abstract**— Special electromagnetic thimble is developed and investigated, allowing the blind to perceive specific 2D graphic information. Electromagnetic thimble is based on the idea, that controllable friction force between thimble and ferromagnetic layer of the screen is related to position of contours or lines and intensity or color of background. Electromagnet with axial symmetry is optimal in respect to the magnetic flux leakage. The magnetic circuit of electromagnet was explored and the model of thimble was designed and investigated. By varying the excitation current in interval [4 mA–14 mA], the attraction force has been varied in interval [0,7 N–6 N]. Initial experiments, supporting the feasibility of the method, were performed by employing blind operator.

**Index Terms**—Blind, graphic information, electromagnetic thimble, magnetic circuit.

## I. INTRODUCTION

Lately a lot of research activity was devoted to the development of a touch screen with tactile feedback [1]–[4]. An initial research results indicate that vibration of the screen or touch screen that plays “sticky”, could make for a better sensory experience on a smooth touch surface, providing texture illusion or “Programmable friction” [5], [6]. The blind person, placing the finger on special thimble and scanning with it the surface of PC tactile screen, perceives specific 2D graphic information in case, when friction force between thimble and screen is related to position of contours or lines and intensity or color of background. While friction force is controlled by applying signal  $U(t)$  to the thimble, whereas the frequency and amplitude of the signal  $U(t)$  is correlated with the color and intensity of lines or contours.

In Fig. 1 two possibilities of electromagnetic thimble realization are presented. In Fig. 1(a), the thimble is placed on a thin ferromagnetic film attached to the PC screen. Attaching the ferromagnetic film on the surface of PC screen reduces the tactile properties of the screen. Fig. 1(b) presents another – attaching the ferromagnetic layer under the screen does not affect tactile properties of the screen, but due to

gap  $\Delta_1$ , the amplitude of the harmonic signal  $U(t)$  should be increased.

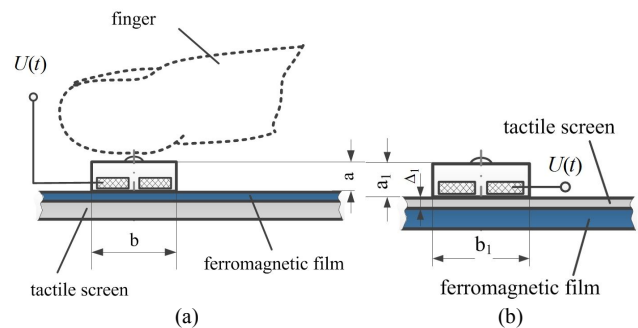

Fig. 1. Two cases of thimble, interacting with ferromagnetic film.

As shown in [7], the frequency range of this kind perception lies for most operators between 2 Hz and 250 Hz allowing them after some training to differentiate among six main colors while intensity of the line or background is related to constant component of friction force. The thimble interacts with ferromagnetic film surely in the case shown in Fig. 1(a), if the film thickness is not more than 1 mm.

In this paper we investigate the case with ferromagnetic film on the tactile screen (Fig. 1(a)) because in the case ferromagnetic under screen (Fig. 1(b)) a lot more power is needed for magnetic field excitation. We propose design of the thimble with minimal magnetic flux leakage, investigate the magnetic circuit of system thimble – ferromagnetic film, propose the technique of the real thimble realization and present the thimble experimental investigation results.

## II. ELECTROMAGNET SHAPE SELECTION

Let us consider magnetic circuit with cross-section, shown in the Fig. 2.

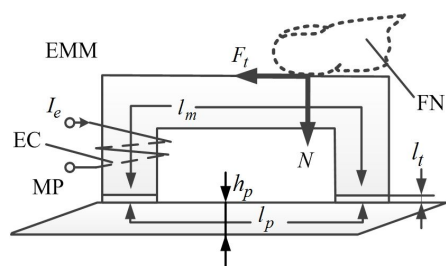

Fig. 2. The electromagnetic magnetic circuit.

Manuscript received February 5, 2013; accepted November 14, 2013.

This research was funded by a grant (No. MIP-042/2011) from the Research Council of Lithuania and Nr. 31V-38 (TactilApps) from Agency for Science, Innovation and Technology. This research was performed in cooperation with the Institutions.

It is composed of  $\Pi$  shape ferromagnetic core EMM with mean length of magnetic line equal to  $l_m$ , of the part of magnetic basic plane MP where the magnetic flux lines are distributed (with the mean length equal to  $l_p$ ) and some intermediate layer  $l_i$  between the magnetic base and the bottom of the electromagnet core. The major part of the magnetic flux is concentrated in the core and basic plane. But some part of magnetic flux created by the coil EC is distributed near the core in the both sides of the core.

The more effective design of electromagnet is with the round electromagnet core. It is shown in Fig. 3. Such design could be performed turning in  $360^\circ$  around the axis superposed with the left side of cross-section the cross-section of the magnet, presented in the Fig. 2.

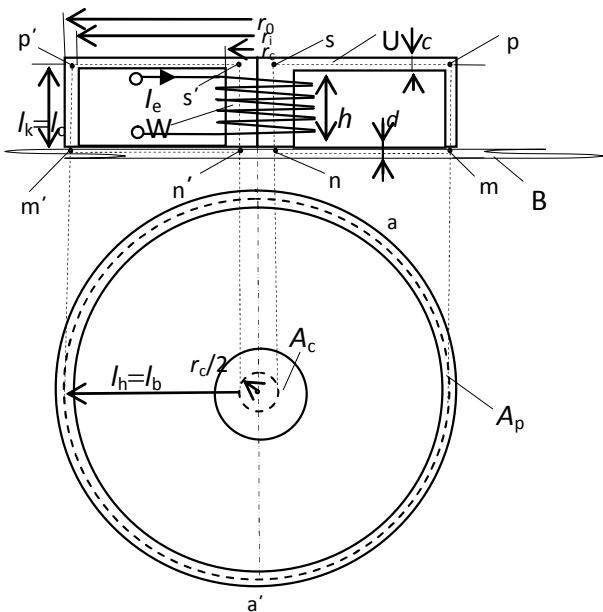

Fig. 3. The round electromagnet: a – cross-section along the electromagnet axis; a' – cross-section perpendicular to electromagnet axis.

In this electromagnet the leakage of magnetic flux through the sidelong surfaces is impossible. Only a little part of magnetic flux closes near the magnetic circuit. It is very actually when we want to reduce the thickness of basic plate. Therefore this electromagnet's design is economically the best.

### III. INTERACTION BETWEEN FINGER AND ELECTROMAGNET

This interaction is shown in Fig. 2. The finger FN acts on the electromagnet with the force  $F_t$  parallel to the base MP. It can be expressed:  $F_t = fN$ , where  $N$  is the normal force, directed perpendicular to the base MP,  $f$  is a coefficient of friction between the bottom of the electromagnet and the basic plane. The electromagnet touches the basic plate by two areas  $A_c$  and  $A_p$  (Fig. 3).

The normal force  $N$  is composed of three components: the weight force  $P$ , the electromagnet attraction force  $T$  and finger pressing force  $F_n$ :  $N = P + T + F_n$ . For blind the variation  $\Delta N$  is important. We suppose that pressing force is constant as the weight force. Therefore the variation of force  $\Delta N$  arises for the electromagnet attraction force variation  $\Delta T$ ,  $\Delta N = \Delta T$ . This variation can be caused by putting the electric current  $I_e$  to the electromagnet coil or varying its value. The

current variation  $\Delta I_e$  is related with magnetic flux variation  $\Delta \Phi$ . In the rest part of this paper by  $T$  we note the variation of attraction force and by  $\Phi$  the magnetic flux variation. Attraction force  $T$  has two components which act to central and peripheral parts of thimble core. The magnetic flux  $\Phi$  is the same in both areas. Force  $T$  depends on  $\Phi^2$

$$T = \frac{\Phi^2}{2\mu_0} (1/A_c + 1/A_p), \quad (1)$$

where  $\mu_0 = 4\pi \cdot 10^{-7}$  H/m – vacuum permeability,  $A_c$  and  $A_p$  are the areas of central and peripheral parts cross-sections of magnetic core, correspondingly. These areas can be expressed as follows

$$A_c = \pi r_c^2, \quad (2)$$

$$A_p = \pi(r_o^2 - r_i^2), \quad (3)$$

where  $r_c$  is radius of magnetic core central part,  $r_i$  – inner and  $r_o$  – outer radii of core peripheral part, correspondingly.

### IV. INVESTIGATION OF ROUND ELECTROMAGNET MAGNETIC CIRCUIT

The analysis was performed for magnetic circuit of thimble presented in Fig. 1(a), supposing that air gap is small and can be not evaluated. Cross-section of the magnetic circuit for round electromagnet in which the magnetic flux  $\Phi$  circulates is shown in the Fig. 3. It is composed of electromagnet core and basic plate. The electromagnet core has three parts with different geometrical parameters. The magnetomotive force is equal to  $M = NI_e$ , where  $N$  is number of coil  $W$  turns,  $I_e$  is the coil current. The equivalent electrical circuit of this magnetic circuit is shown in Fig. 4. The magnetic resistance  $R_{mc}$  presents the geometrical and magnetic properties of cylindrical central part of magnetic core. The magnetic resistance  $R_{mu}$  presents the upper side  $U$  of core with thickness  $c$  (Fig. 3) which joins the central and peripheral parts. The magnetic resistance of peripheral cylindrical part is noted as  $R_{mp}$ . The magnetic resistance of basic plate is noted as  $R_{mb}$ . Magnetic voltages  $U_{mc}$ ,  $U_{mu}$ ,  $U_{mp}$  and  $U_{mb}$ , correspondingly, fall in presented resistances.

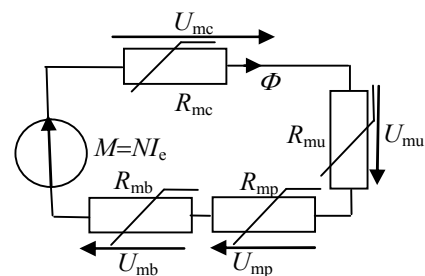

Fig. 4. The magnetic circuit of the round electromagnet.

Let we know the attraction force  $T$  must be created by electromagnet. From (1) we can find magnetic flux  $\Phi$  needed to create this attraction force. The problem is to find the magnetomotive force  $NI_e$ . By Kirchoff's voltage equation

$$NI_e = U_{mc} + U_{mu} + U_{mp} + U_{mb}. \quad (4)$$

Supposing that magnetic flux is distributed uniformly in all volume of magnetic resistances  $R_{mc}$  and  $R_{mp}$  we express magnetic voltages  $U_{mc}$  and  $U_{mp}$  as follows:

$$U_{mc} = \frac{\Phi l_c}{\mu_0 \mu_r(B_c) A_c}, \quad (5)$$

$$U_{mp} = \frac{\Phi l_p}{\mu_0 \mu_r(B_p) A_p}. \quad (6)$$

The values  $\mu_r(B_c)$  and  $\mu_r(B_p)$  can be found of magnetisation curve  $B(H)$  for chosen ferromagnetic material [8], evaluating that  $B_c = \Phi/A_c$  and  $B_p = \Phi/A_p$ . The mean magnetic lines lengths of magnetic core central  $l_c$  and peripheral  $l_p$  parts are the same

$$l_c = l_p = h + (d + c)/2, \quad (7)$$

where  $h$  is height of central core part,  $c$  and  $d$  are thicknesses of upper side and basic plate, correspondingly.

In basic plate and in upper side of magnetic core the magnetic flux is non-uniform because the cross-section areas vary along the radius  $r$  in both volumes. Therefore,  $B$  and  $\mu_r$  vary, too. The mean lines of magnetic flux lay between the radii from  $0,5r_c$  to  $0,5(r_0 + r_1)$ . For any  $r$  in this interval the cross-section area of upper side or basic plate is  $A_b(r) = A_u(r) = 2 \pi r x$ , where  $x = d$  for the basic plate and  $x = c$  for the upper side of the core.

Supposing that the directions of vector  $\mathbf{B}$  and radius  $r$  coincide, we can express the magnetic voltages  $U_{mu}$  and  $U_{mb}$

$$\begin{aligned} U_{mu} = U_{mb} &= \int_{0,5r_c}^{0,5(r_0+r_1)} \frac{B dr}{\mu_r(B) \mu_0} = \\ &= \frac{\Phi}{2\pi \mu_0 x} \int_{0,5r_c}^{0,5(r_0+r_1)} \frac{dr}{\mu_r(r) \cdot r} = \frac{\Phi}{2\pi \mu_0 x} \int_{\ln(0,5r_c)}^{\ln(0,5(r_0+r_1))} \frac{d \ln r}{\mu_r(\ln r)}, \end{aligned} \quad (8)$$

Evaluating geometrical sense of the definite integral we can write finely

$$U_{mu} = U_{mb} = \frac{\Phi}{2\pi \mu_0 \cdot x} \cdot Q_m \cdot \ln \frac{r_0 + r_1}{r_c}, \quad (9)$$

where  $Q_m$  is the mean value of function  $Q = 1/\mu_r(\ln r)$  in the interval  $[r_{min} = 0,5r_c, r_{max} = (0,5r_0 + 0,5r_1)]$ .

We obtain the function  $Q = 1/\mu_r(\ln r)$  from the magnetisation curve  $B(H)$ . The  $B(r)$  value in upper side and basic plate depends on  $r$  by this relation

$$B_{b(u)} = \Phi/x \cdot 2\pi r. \quad (10)$$

After logarithm taking we have  $\ln B = -K \ln r$ , ( $K = \Phi/2\pi x = \text{const}$ ). Therefore the mean value  $Q_m$  of function  $Q = 1/\mu_r(\ln r)$  calculated in the interval  $[r_{min}, r_{max}]$  coincides with the mean value of function  $Q = 1/\mu_r(\ln B)$  calculated in the interval  $[B_{b(u)min}, B_{b(u)max}]$ .  $B_{bmin}$ ,  $B_{bmax}$  and  $B_{umin}$ ,  $B_{umax}$  are the minimal and maximal values of magnetic

flux density in basic plate and in the upper side, correspondingly.

The minimal flux densities  $B_{bmin}$ ,  $B_{umin}$  are in cross-section with maximal radius  $r_{max}$ , the maximal flux densities  $B_{bmax}$ ,  $B_{umax}$  are in cross-section with minimal radius  $r_{min}$ . Substituting  $r_{max}$  and  $r_{min}$  into (10) and evaluating that  $x = d$  for basic plate and  $x = c$  for upper side we obtain:

$$B_{bmin} = \Phi/\pi(r_0+r_1) \cdot d, \quad (11)$$

$$B_{umin} = \Phi/\pi(r_0+r_1) \cdot c, \quad (12)$$

$$B_{bmax} = \Phi/\pi r_c \cdot d, \quad (13)$$

$$B_{umax} = \Phi/\pi r_c \cdot c. \quad (14)$$

The procedure of  $Q_m$  calculation is explained below.

## V. REALIZATION OF THIMBLE AND MAGNETIC CIRCUIT CALCULATION

The thimble geometrical parameters were chosen as follows:  $r_0 = 10,57$  mm,  $r_1 = 9,74$  mm,  $r_c = 2,6$  mm,  $c = 1$  mm,  $h = 5$  mm. Such parameters are suitable with finger dimensions. The thimble is convenient for pushing by finger on the plane. Again the dimensions of inner volume of thimble must be sufficient for excitation coil placement.

The thimble must be made of the soft magnetic material with narrow hysteresis loop and little coercivity. The best steel suitable for electromagnets is carbon steel AISI 1020. But in the basic plate and upper core side the ratio of maximal and minimal values of magnetic flux densities is  $B_{max}/B_{min} = r_{max}/r_{min} \approx 7,8$ . In this diapason of magnetic flux densities the relative permeability  $\mu_r$  of AISI 1020 varies in very large limits. The magnetic circuit becomes very nonlinear. By this reason the steel AISI 1030 was used. Basic plate was made of the same steel AISI 1030 with thickness  $b = 1$  mm.

The preliminary experimental investigation shows, that graphic information can be presented to the blind surely when the force  $F_t$  which acts to the blind finger varies in interval  $[0,5; 2,5$  N]. The weight force is 0,68 N. Evaluating the friction coefficient  $f = 0,38$  for the pair composed of two metallic surfaces of steel AISI 1030, we obtain that attraction force must be about  $T = 6$  N. By (2) and (3) the area of central core part is  $A_c = 21,2$  mm<sup>2</sup> and the area of the peripheral part is  $A_p = 53,0$  mm<sup>2</sup>. From (1) we get the value of flux  $\Phi$  which circulates in the magnetic circuit of the thimble

$$\Phi = \sqrt{\frac{2\mu_0 \cdot T}{(1/A_c) + (1/A_p)}} = \sqrt{\frac{8\pi \cdot 10^{-7} \cdot 6}{0,066 \cdot 10^6}} = 1,5 \cdot 10^{-5} \text{ Wb}. \quad (15)$$

The magnetic flux densities in central and peripheral parts are:  $B_c = \Phi/A_c = 0,71$  T,  $B_p = \Phi/A_p = 0,28$  T. From data presented for AISI 1030 in [8] we find  $\mu_r(B_c) \approx 510$  and  $\mu_r(B_p) \approx 850$ . The magnetic voltages  $U_{mc}$  and  $U_{mp}$  from (5) and (6) are:

$$U_{mc} = \frac{B_c l_c}{\mu_0 \mu_r(B_c)} \approx \frac{0,71 \cdot 5 \cdot 10^{-3}}{4\pi \cdot 10^{-7} \cdot 510} \approx 5,57 \text{ A}, \quad (16)$$

$$U_{mp} = \frac{B_p I_p}{\mu_0 \mu_r (B_p)} \approx \frac{0,28 \cdot 5 \cdot 10^{-3}}{4\pi \cdot 10^{-7} \cdot 850} \approx 1,31 \text{ A.} \quad (17)$$

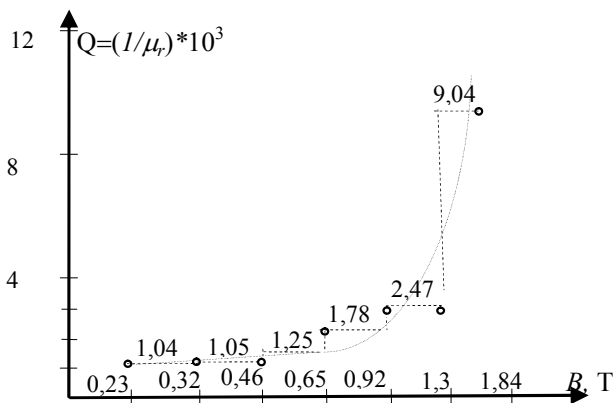

Fig. 5. The dependence of  $1/\mu_r$  on  $B$  in logarithmic scale.

In Fig. 5 it is shown the dependence  $Q = (1/\mu_r) \cdot 10^3$  on  $B$  in logarithmic scale. From (11)–(14) we obtain  $B_{\max} = 1,84$  T and  $B_{\min} = 0,23$  T. The dependence  $Q(\ln B)$  was calculated of data presented in [8] for AISI 1030. By broken dashed lines it is presented the mean values of  $Q(\ln B)$  for six intervals with ratio of maximal and minimal values is  $B_{\max}/B_{\min} = \sqrt{2}$ . The mean value of  $Q$  calculated for all six intervals is 2,77. The mean relative permeability is  $\mu_r \approx 358$  in  $B$  interval  $[0,23\text{T}–1,84\text{T}]$ . Substituting calculated values  $\Phi$ ,  $\mu_r$  and geometrical parameters in (7) we obtain  $U_{mb} = U_{mu} \approx 10,9$  A. Needed value of magnetomotive force is

$$M = U_{mc} + U_{mb} + U_{mp} + U_{mu} \approx 28,7 \text{ A.} \quad (18)$$

To obtain this magnetomotive force the coil with  $N = 2050$  turns of 0,07 mm diameter copper wire was wound. The value of  $M = NI_c = 28,7$  A will be reached when  $I_c = 0,014$  A. Time constant of excitation coil is small and information for blind can be presented not only by force variation but and by frequency variation in interval [2 Hz–250 Hz].

## VI. EXPERIMENTAL INVESTIGATION OF THIMBLE

The experimental investigation of thimble was performed on special stand designed for friction force measurement.

The experiment was made after treatment of basic plate surface by two different materials. The static friction force was measured moving the thimble with constant velocity  $v = 0,08$  mm/s along the basic plate. The results were fixed for three different values of normal force:  $N = 0$ ,  $N = 0,49$  N,  $N = 0,98$  N when current in the thimble coil was absent  $I = 0$  and when the thimble was excited by maximal current  $I_c = 0,014$  A. The results are presented in the Table I.

Attraction force  $T$  depends on excitation current non-linearly. The steepness of this dependence decreases for maximal current values because steel saturates. Decrease of steepness for low values of current can be explained by Fig. 7. There the dependence of magnetomotive force and sum of magnetic voltages on excitation current is presented.

Lesser sum of magnetic voltages than magnetomotive force shows that some magnetic voltage falls in the air gap between basic plate and magnetic core which we are not evaluated in magnetic circuit analysis. But it is actually for values of current less than 8 mA only.

TABLE I. RESULTS OF FRICTION FORCE MEASUREMENT.

Treatment	Surface roughness Ra, $\mu\text{m}$	Normal force, N					
		0			0,4		
		$I_c=0\text{A}$			$I_c=0,014\text{A}$		
Measured friction force, N							
sodium	0,980	0,26	0,52	0,78	2,53	2,67	2,92
fine sand	1,261	0,29	0,48	0,63	2,58	2,60	2,62

Attraction force dependence on the coil current was investigated, too. The results are presented in the Fig. 6 and Fig. 7.

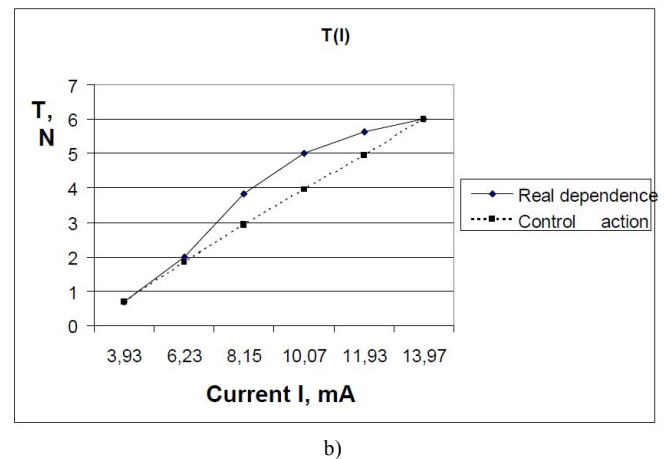
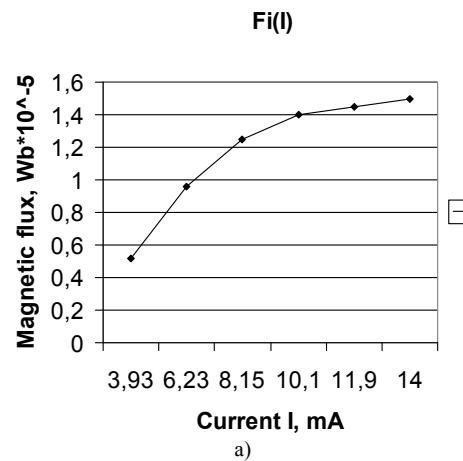

Fig. 6. Dependence the magnetic flux (a) and attraction force  $T$  (b) on the coil excitation current.

The nonlinearity of function  $T(I)$  can be eliminate easily by computer. We will have the linear dependence the attraction force on control action  $u$  if we relate control action with needed excitation current  $I$  (see Fig. 6(b)).

Initial experiments were made by employing one blind operator; the task was to find the door in a room (laboratory), using ferromagnetic pad and computer mouse, attached to electromagnetic thimble. There were well expressed contours of the white door in rather grey wall and blind operator after some time found the right direction. He

felt well the force magnitude variation and the frequency variation.

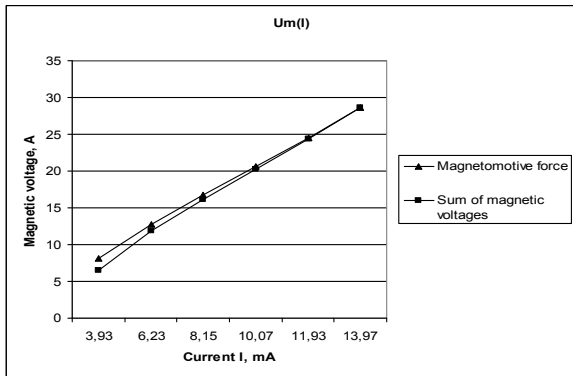

Fig. 7. The dependance of magnetomotive force and sum of magnetic voltages on the current.

Therefore the magnetic thimble can be used to give the 2D graphic information for blind person quite effectively.

## VII. CONCLUSIONS

Specific 2D graphic information from PC can be presented for blind person on tactile screen. The original electromagnetic thimble on ferromagnetic film is purposed to perceive this information by friction force varying. Electromagnet with axial symmetry is optimal for thimble in respect to the magnetic flux leakage. The analysis of magnetic circuit was performed. The carbon steel with soft

magnetisation characteristic for thimble realisation must be used. The real thimble was presented and investigated. By varying the excitation current in interval [4 mA–14 mA], the attraction force has been varied in interval [0,7 N–6 N]. The experimental investigation shows that proposed thimble can be used for the blind orientation effectively. The information can be presented by the force magnitude or by the frequency variation.

## REFERENCES

- [1] I. Poupyrev et al., "Apparatus and method for touch screen interaction based on tactile feedback and pressure measurement", United States Patent 7952566 B2, May 31, 2011.
- [2] J. M. Owen, J. A. Petro, S. M. D'Souza, R. Rastogi. "An improved, low-cost tactile 'mouse' for use by individuals who are blind and visually impaired", in *Proc. 11th Int. ACM SIGACCESS Conf. on Computers and accessibility*, ACM New York, 2009.
- [3] J. Rantala, "Vibrating touchscreen devices could get braille tweak for blind users", Research Directory of University of Tampere, Finland, 2009.
- [4] I. Poupyrev, et al., "A touch screen with texture. Electro-vibration could make for a better sensory experience on a smooth touch surface", *User Interface Software and Technology (UIST) symposium*, New York City, October 13, 2010.
- [5] M. Paul, "Nokia touchscreen creates texture illusion", *New Scientist*, Sept. 2010.
- [6] V. Levesque, "A touch screen that plays sticky. "Programmable friction" provides a new kind of feedback", *Acm Conf. on Human Factors in Computing Systems*, Vancouver, May 10, 2011.
- [7] A. Zvironas, M. Gudauskis, "Investigation of attraction force and vibration of a slipper in a tactile device with electromagnet", *Journal of Vibroengineering*, vol. 13, no. 4, pp. 856-860, Dec. 2011.
- [8] [Online]. Available: <http://www.fieldp.com/magneticproteties.html>.