

Research into elements of the multifunctional deformation zones of a car body

J. Sapragonas*, **D. Juodvalkis****, **R. Makaras*****, **R. Keršys******

*Kaunas University of Technology, Kęstučio 27, 44312 Kaunas, Lithuania

**Kaunas University of Applied Engineering Sciences, Tvirtovės al. 35, 50155 Kaunas, Lithuania,

E-mail: djuodvalkis@yahoo.com

***Kaunas University of Technology, Kęstučio 27, 44312 Kaunas, Lithuania, E-mail: rolandas.makaras@ktu.lt

****Kaunas University of Technology, Kęstučio 27, 44312 Kaunas, Lithuania, E-mail: robertas.kersys@ktu.lt

crossref <http://dx.doi.org/10.5755/j01.mech.19.2.4170>

1. Introduction

Designing of the new products in automotive industry often involves taking into consideration specific criteria set for vehicles besides general ones such as functionality, and operating costs to price ratio. Recently, the efforts focused on the groups of criteria regulating sustainable development of transportation system, namely energy consumption, environmental pollution, general safety of motor vehicles with respect to crew and environment. Each of these groups had influenced the methodology used for designing car body, and have required for comprehensive theoretical and practical studies. In automobiles, the spatial thin-walled profile structures covered with the shell-type components ensuring the best quality/mass ratio are used as structural elements of a car body [1]. This has initiated intensive both theoretical and applicable studies.

The calculation techniques of thin-walled profiles applied by S. P. Timoshenko [2] for estimation of the strength and consistency in range of elasticity, have been further extended by theoretical and applicable studies to include plastic deformations under dynamic loads [3-5]. The characteristics of elements with the predictive course of plastic deformations have been found, and it has enabled to use some components performing a function of supporting structures as the deformable components within safety zones [6, 7]. After the improved and more precise methodologies for the assessment of component strength and stiffness became available, gradually, by designing the support structures, multifunctional components came into use, for example, elements of chassis and other structures were used as the energy absorbing elements of deformation zones. The necessity to optimize the structure according to many contradictory criteria made automotive manufacturers to develop complex software packages which in turn reduced chances for minor companies to take part in the process of designing and development.

Currently, a trend towards use of an extra criterion is observed, namely – a customer satisfaction/price. Use of the latter criterion is associated with the individualization of a car by distinguishing it from mass produced serial vehicles. It provides small companies with good opportunities. Individualization potentially includes a vast field of needs, and modern technologies, including smart materials and smart technologies, can be currently used by small companies as well. Simultaneously, the designer should allow the user to assess to what extent his/her needs can be satisfied. When recovering old structures the user, knowing

that old structures are unable to ensure safety, should be informed about structural and technological possibilities and the price of desired result in order to better assess the risks in comparison with modern systems. Advanced and universal software packages allow for designing car bodies using generalized characteristics, by satisfying customer's order more completely and increasing competitiveness.

This paper involves examination of operating conditions of replaceable elements of frontal safety deformation zones, and influence of individual elements in absorption of impact energy, while determining qualities of these elements based on generalized deformational characteristics. The objective of the research is to investigate the influence of the changes in characteristics of multifunctional elements and introduction of additional elements on the dynamic processes of impact within deformation zones under consideration.

2. The dynamic model of frontal deformation zone

Modern software packages allow for assessment of car body deformations, however for the purpose of preliminary evaluation, simpler models are more handy that allow for more precise specification of interaction among individual deformation zones, and influence of the replaced or additional structural components. Using simple dynamic models makes it possible to readily examine possibilities of the structure. Such models are made based on the principle of multidimensional mechanic systems, and are currently used for the assessment of the effect of individual elements within complex safety system. Principles of formulating models are provided in Ni, C. M.; Song, J. O. [8].

The model under consideration here provides for a three-mass dynamic system with nonlinear elastically-plastically deformed elements (Fig. 1). A three-mass dynamic model is one of the simplest however sufficiently precisely reflecting key features of a car's frontal deformation zone.

The deformation zone under consideration in the model is divided into three sections as follows: zone 1 – bumper zone ranging from bumper to radiator; zone 2 – the engine zone ranging from the radiator to the engine; zone 3 – the car body zone including the space between the engine and car interior front panel. Such a partition of the model into three zones is conditional. Each section reflects a particular zone that includes units present within this zone.

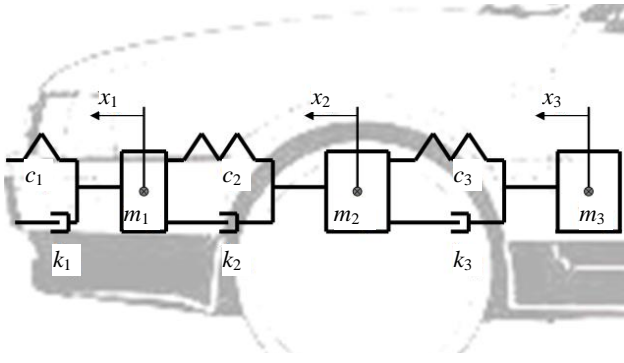

Fig. 1 The three mass dynamic model where: m_i - represents masses of deformational zones, kg; c_i - rigidities of deformational zones, kN/m; k_i - coefficients of suppression of deformational zones, kNs/m; x_i - displacement of mass m_i , m

The behaviour of the model is described using differential equations:

$$\begin{cases} m_1 \ddot{x}_1 + k_1 \dot{x}_1 + c_1 x_1 + k_2 (\dot{x}_1 - \dot{x}_2) + c_2 (x_1 - x_2) = \\ = F_{k_2} - F_{k_1}; \\ m_2 \ddot{x}_2 + k_2 (\dot{x}_2 - \dot{x}_1) + c_2 (x_2 - x_1) + k_3 (\dot{x}_2 - \dot{x}_3) + \\ + c_3 (x_2 - x_3) = F_{k_3} - F_{k_2}; \\ m_3 \ddot{x}_3 + k_3 (\dot{x}_3 - \dot{x}_2) + c_3 (x_3 - x_2) = -F_{k_3}. \end{cases} \quad (1)$$

For the purpose of calculations a program was developed based on the computer applications previously developed in the Department of Transport Engineering of Kaunas University of Technology for simulation of the shock impact. Description of nonlinear elastically plastic elements c_1 , c_2 and c_3 uses generalized, experimentally established load-deformation relationships (Fig. 2).

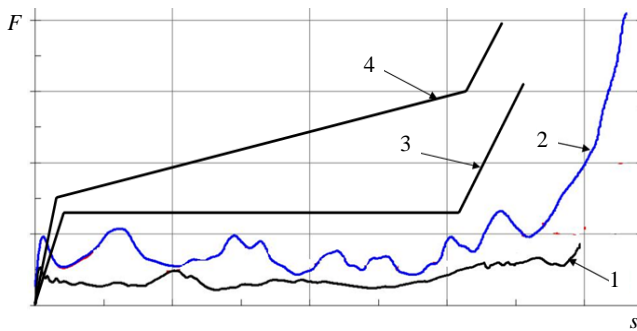

Fig. 2 Deformation characteristics of the elements in generalized typical deformation zone: 1 - quasistatic experiment; 2 - the relationship predicted using software package LS-DYNA; 3 - under plastic deformation with constant deformation force; 4 - with the progressive characteristic

Modern car energy absorbing elements use deformation elements of the following two types - the elements with uniform cross sections with lost local con-

sistency undergo deformation under constant load (Fig. 2, curve 3). Deformation happens in the same way for different foam plastics used in energy absorbing elements. The elements with non-uniform cross section or variable wall thickness undergo deformation by progressively increasing the force, required for their plastic deformation (Fig. 2, curve 4).

Formerly, the elements used in deformation zones also featured a partially inversed relationship - upon loss of consistency, the load decreased and only afterwards reached stabilization. Experimental findings reflect specific patterns of local deformations development - the process is not absolutely consistent (Fig. 2, curve 1).

Deformation characteristics of individual elements can also be predicted using FEM (finite element method) software packages. Fig. 2 (curve 2) shows the course of deformation predicted using LS-DYNA software package of the longeron with rectangular cross section under compression [9]. This software package is used to predict local process deviations in course of deformation that can increase spread of results thus when determining characteristics of element-model it's worth using integral characteristics, for example, relationships deformation-the amount of absorbed energy.

Based on the selected data in Fig. 2, the descriptions of individual deformation non-linear elastically plastic elements c_1 , c_2 and c_3 were made under compression of the element. Relationships were defined using variables s_i for the description of the deformation of the element:

$$\left. \begin{aligned} s_1 &= x_1; \\ s_2 &= x_2 - x_1; \\ s_3 &= x_3 - x_2. \end{aligned} \right\} \quad (2)$$

Prior to commencement of the plastic deformation, a model of elastic deformations was used. From the start of plastic deformations, calculation of the course of deformations is changed depending on the speed of process:

$$\begin{aligned} c &= c_+; F_k = F_{k_1} & \text{when } \dot{s} > 0 \\ c &= c_-; F_k = F_{k_1}^* & \text{when } \dot{s} < 0 \end{aligned} \quad (3)$$

where c_+ is stiffness of the element in progress of deformation (can be negative); c_- is stiffness during kick-back (of the elastic deformation), set in the beginning of calculation for each part of the relationship force-deformation (Fig. 3).

Permanent deformations for the point A (Fig. 3) are calculated as follows:

$$s_{pr} = s^* - F_A / c_-, \quad (4)$$

where F_A is a force, correspondent to the point A.

Developing a more precise description of elements within deformation zone should be focussed on the last phase of the zone deformation - the final zone deformation making it totally flat. In this case, the zone becomes stiffer, and this stiffening of the zone has been simulated assuming that F_{lim} is achieved when elastically deforming the rest part of the deformation zone.

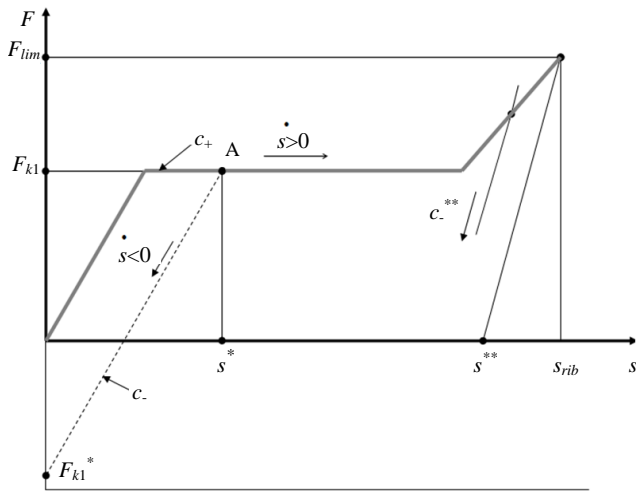

Fig. 3 Description of the elements' relationships load-deformation used in the model

Suppressive elements k_i are used for compensation of the load dependency on the speed of deformation, which is observed in majority of cases when buckling energy absorbing closed-profile thin-walled elements [10].

The model showed in Fig. 1 can be supplemented by providing additional elements of decorative or any other nature in front of the bumper (Fig. 4). Additional elements made of rubber or foam plastic can be mounted in front bumpers of trucks to significantly reduce outcomes of car accidents during the impact of a motor vehicle with the truck [11].

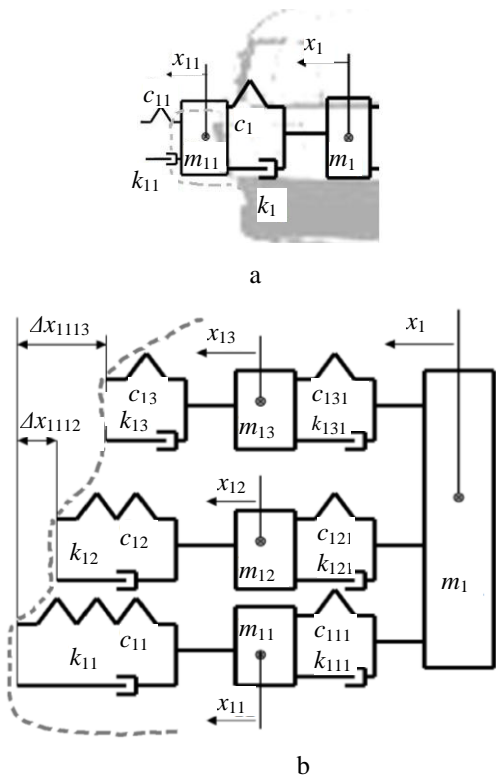

Fig. 4 Additional models of elements of the frontal deformation zone: a – with the band of foam or rubber plastic; b – models with the aerodynamic fairing and pedestrian safety elements

For the purpose of assessing the influence of such elements on the deformation zone, some simpler (Fig. 4, a)

or more complex (Fig. 4, b) are possible, in contact with the obstruction at different points of time. Consequently, additional masses are introduced into the equation system (1). This requires for formulation of relationships of force–deformation of additional elements c_{ijk} . As elements are usually made of foam plastic or rubber band, their descriptions are made selecting force–deformation relationships based on Types 3 and 4 from Fig. 2.

3. Results of the frontal deformation zone simulation

Values of the model presented in Fig. 1 depend on the task to be solved. To ensure maximum reliability of the results obtained, the conditions of car crash testing are strictly regulated. Consequently, in order to assess to what extent the zones in old structures satisfy modern requirements, it is necessary for testing conditions to conform to current regulations. Another condition for model development is definition of the element or group of elements under research. The fraction of the impact energy absorbed by the elements under the research within given deformation zone is distinguished. Masses of individual zones are then respectively adjusted.

The fraction of the impact suffered by the longeron was determined through analysis of NHTSA crash-test results [12]. Values c_i were found from relationships of absorbed energy ($W = W(s)$) which have been determined experimentally (Fig. 5).

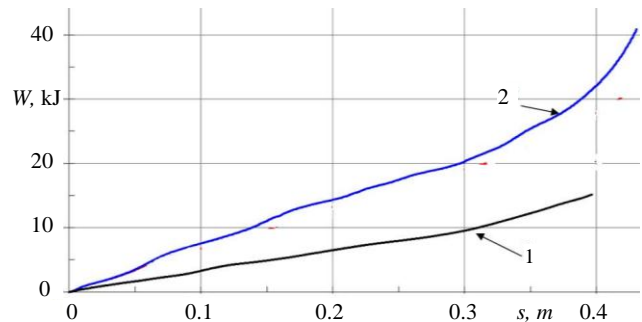

Fig. 5 Schemes of the longeron absorbed energy–axial displacement: 1 – a quasi-static experiment; 2 – numerical experiment (LSDYNA) while buckling the longeron under dynamic load

The characteristics of the first zone (stiffness, suppression, length) were specifically chosen to make it possible to fully stop the simulated car with the mass of 1376 kg and initial speed of 15 km/h. The characteristics of the second zone were chosen based on the findings of field experiments that have been performed on the longeron of AUDI 100 manufactured in 1990, and that of numerical models. The actual relationship of buckling force–axial shortening was approximated by the curve defined by five control points.

Particular numerical values within force–deformation relationships can be found in several different ways. Values of preliminary critical forces of longerons and other thin-walled closed-profile rods can be calculated using the analytical expression suggested by S. P. Timoshenko [2] for the calculation of critical stresses of the thin-walled cylindrical rods under compression. This equation results in condition that establishes ratio of geometric dimensions of the rod when critical stresses of

the element under buckling are achieved before the material experiences its plastic deformation:

$$\frac{d}{t} \geq \frac{2}{\sqrt{3(1-\nu^2)}} \frac{E}{\sigma_y}, \quad (4)$$

where t is thickness of wall of cylinder [m]; d is mid diameter of cylinder, m; E is Young's modulus, GPa; ν is Poisson's ratio, σ_y is yield strength of material, MPa.

As the elements featuring effective energy absorption are deformed within the area of plastic deformations, the critical force F_{kr} of the square profile pipes is

found using the following expression:

$$F_{kr} = \frac{E^* \pi^2 t^3}{3(1-\nu^2) b^2}, \quad (5)$$

where $E^* = \sqrt{EE_t}$, E_t is a tangential module in the diagram of the material compression above the yield strength, b is width of the element under buckling [m].

Values used for the static simulation are presented in Table 1.

Table 1

The characteristics of deformation zones used in calculations

Nr.	Zone 1 ($m_1 = 80$ kg)					Zone 2 ($m_2 = 280$ kg)					Zone 3 ($m_3 = 1016$ kg)				
	s_{lim} , mm	F_{lim} , kN	k_+ , kNs/m	c_- , kN/m	k_- , kNs/m	s_{lim} , mm	F_{lim} , kN	k_+ , kNs/m	c_- , kN/m	k_- , kNs/m	s_{lim} , mm	F_{lim} , kN	k_+ , kNs/m	c_- , kN/m	k_- , kNs/m
1.	20	20	2.03	280	2.03	10	130	6.12	700	5.65	10	180	15.32	1500	15.32
2.	75	20	2.03	280	2.03	100	80	6.12	700	5.65	100	180	15.32	1500	15.32
3.	90	40	2.03	280	2.03	150	130	6.12	700	5.65	150	300	15.32	1500	15.32
4.						270	75	6.12	700	5.65					
5.						360	180	6.12	700	5.65					

Results obtained through numerical simulation are presented in Figs. 6 and 7.

Fig. 6 shows dependencies of the vehicle deceleration on time, when using the model for simulation of the impact with stiff barrier under two different initial speeds.

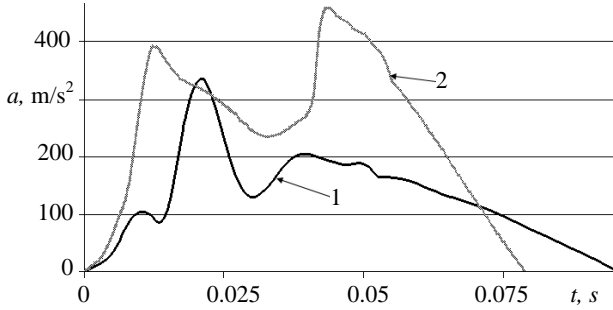

Fig. 6 Vehicle deceleration under different impact speeds. 1 – initial speed 30 km/h; 2 – initial speed 56 km/h

The level of danger of the dynamic impact process can be assessed through calculation of head injury criterion (HIC) value which is used to measure the magnitude and duration of deceleration [13]. The obtained value, obviously, cannot be used to judge on damages suffered by the crew of the vehicle. HIC value is mathematically expressed as dependencies of accelerations caused within head on the maximum numerical value of the integral of time curve within a particular interval [14].

$$HIC = \left\{ \left[\frac{1}{t_2 - t_1} \int_{t_1}^{t_2} a dt \right]^{2.5} (t_2 - t_1) \right\}, \quad (6)$$

where: t_1 and t_2 are used to define the range of time interval, within which the maximum HIC value is obtained; a is accelerations, expressed through the multiplier of a free-fall acceleration g .

According to the dependencies of acceleration

represented in Fig. 6, under the initial speed of impact of 30 km/h the calculated HIC value is 70. This HIC value is achieved within 0.016 - 0.052 s time interval. The maximum value of deceleration is 330 m/s².

Under the initial speed of impact of 56 km/h the maximum HIC value is 230 and it is achieved within 0.018 - 0.054 s time interval. The first peak deceleration value is obtained at 0.013 second, and amounts for 390 m/s², whereas the second peak deceleration value is obtained at 0.045 second, and amounts for 470 m/s².

Fig. 7 shows the distribution of the amount of energy absorbed by different zones in time.

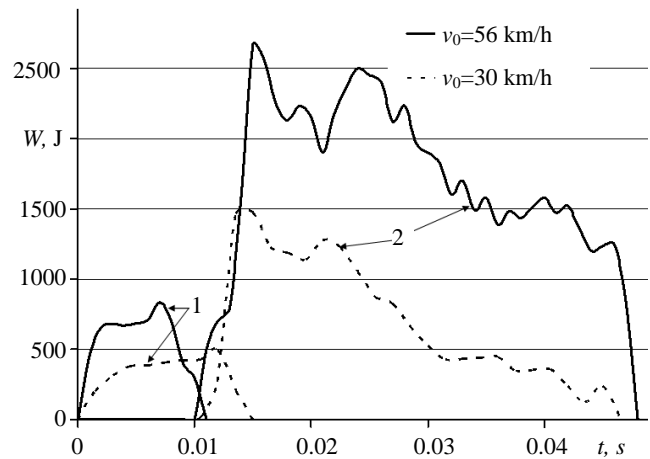

Fig. 7 Distribution of the absorbed energy in time under different impact speeds: 1 – zone 1; 2 – zone 2

The results obtained after the model was improved by adding the supplementary band, parameters of which are defined in Table 2, are presented in Fig. 8.

Table 2
The characteristics of additional deformation zone II

Nr.	s_{lim} , mm	F_{lim} , kN	k_{+} , kNs/m	c_{-} , kN/m	k_{-} , kNs/m
1.	20	5	0.52	220	0.52
2.	100	7.5	0.52	220	0.52

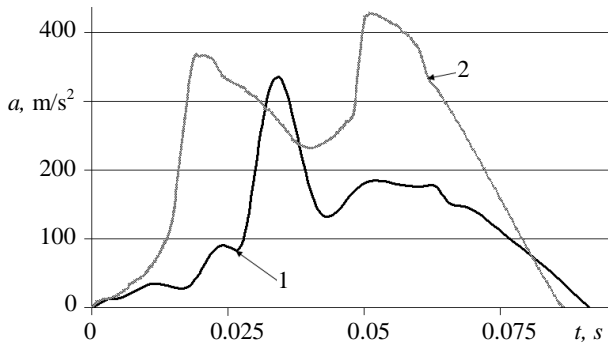

Fig. 8 Deceleration of vehicle with additional deformation elements under different impact speeds. 1 – initial speed 30 km/h; 2 – initial speed 56 km/h

Examination of dependencies showed in Fig. 8 resulted in finding that $HIC = 65$ under the impact speed of 30 km/h, whereas maximum deceleration was found to be 325 m/s^2 . Under the impact speed of 56 km/h, the calculated maximum HIC value was found to be 210, whereas maximum deceleration – 420 m/s^2 .

As it can be observed from Figs. 6 and 8, additional deformation elements made of foam plastic or rubber introduced at the front of the vehicle contribute, although insignificantly, to the change in course of vehicle deceleration process during the impact, leading to increased duration of the process and reduced values of peak deceleration. These changes are more significant under the impact speed of 56 km/h.

Fig. 9 presents distribution of the energy absorbed by deformation zones in time, with the additional deformation elements introduced at the front of the vehicle.

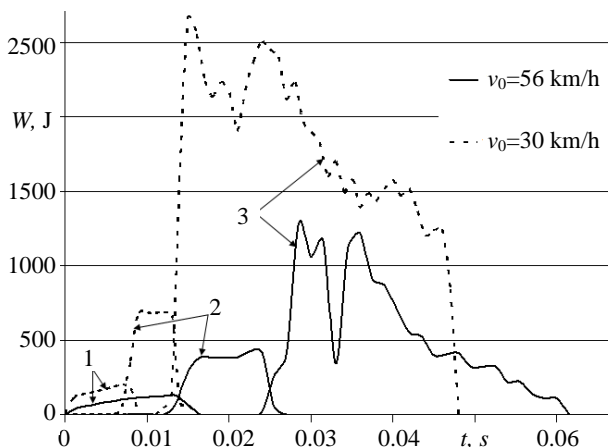

Fig. 9 Distribution of the absorbed energy in time under different impact speeds and with the introduced additional deformation elements: 1 – zone II; 2 – zone I; 3 – zone 2

As it can be observed from Figs. 7 and 9, introduction of the additional deformation elements at the front of the vehicle leads to reduction in the amount of energy

absorbed by the first deformation zone. This is due to the reduction in speed of deformation of the first zone, which is reduced by the additional zone II.

Meanwhile, the amount of energy absorbed by the second deformation zone remains practically the same as it was without any additional deformation elements.

4. Conclusions

1. Simple dynamic models were developed that enable sufficiently precise simulation of car frontal impacts and determination of the effect of changes in characteristics of deformation zones on the dynamic processes of impact.

2. The developed dynamic models can be used for assessment of the effect of additionally installed aerodynamic or different-nature multifunctional elements on the behaviour of deformation zones.

3. Research performed using dynamic models showed that introduction of additional deformation elements made of foam plastic or rubber at the front of the car, lead to changes in behaviour of deformation zones.

4. Additional elements made of foam plastic or rubber (zone II) absorb a particular amount of energy and reduce initial speed of deformation of the subsequent deformation zone (zone I) that in turn results in the reduced amount of the energy absorbed by the latter.

5. Additional elements made of foam plastic or rubber serve to mitigate the process of the impact. In case of simulating the impact with the barrier at the initial speed of 56 km/h, the peak deceleration value was found to be reduced by 10%, from 470 m/s^2 (no additional elements) to 420 m/s^2 .

6. When assessing the level of danger of the impact process through HIC, a positive effect coming from additional plastic or rubber elements was obviously observed: under the initial speed of impact of 56 km/h and in the absence of additional elements $HIC = 230$, whereas in presence of additional elements $HIC = 210$.

References

1. **Fenton, J.** 1998. Handbook of Automotive Body Construction and Design Analysis. London, Professional Engineering Publishing, 455 p.
2. **Timoshenko, S.; Young, D.** 1968. Elements of strength of materials, Van Nostrand, 377 p.
3. **Wierzbicki, T.; Abramowicz, W.** 1983. On the crushing mechanics of thin-walled structures, Journal of Applied Mechanics 50: 727-734. <http://dx.doi.org/10.1115/1.3167137>.
4. **Abramowicz, W.; Jones, N.** 1986. Dynamic progressive buckling of circular and square tubes, International Journal of Impact Engineering 4: 243-270. [http://dx.doi.org/10.1016/0734-743X\(86\)90017-5](http://dx.doi.org/10.1016/0734-743X(86)90017-5).
5. **Karagiozova, D.; Jones, N.** 2001. Dynamic effects on buckling and energy absorption of cylindrical shells under axial impact, Thin-Walled Structures 39: 583-610. [http://dx.doi.org/10.1016/S0263-8231\(01\)00015-5](http://dx.doi.org/10.1016/S0263-8231(01)00015-5).
6. **Seiffert, U.; Wech, L.** 2007. Automotive Safety Handbook, Warrendale, SAE International, 306 p.
7. **Huang, M.** 2002. Vehicle Crash Mechanics, London, CRC Press, 489p.

8. **Ni, C.M.; Song, J.O.** 1986. Computer-Aided Design Analysis Methods for Vehicle Structural Crashworthiness, Symposium on Vehicle Crashworthiness Including Impact Biomechanics, ASME, AMD-Vol.79/BED-Vol.1, 125-139.
9. LS-DYNA Keyword User's Manual, 2006. Livermore Software Technology Corporation, 2500 p.
10. **Karagiozova, D.; Jones, N.** 2004. Dynamic buckling of elastic-plastic square tubes under axial impact—II: structural response, International Journal of Impact Engineering 30: 167-192.
[http://dx.doi.org/10.1016/S0734-743X\(03\)00062-9](http://dx.doi.org/10.1016/S0734-743X(03)00062-9).
11. **Krusper, A.; Thomson, R.** 2012. Truck frontal under-ride protection – compatibility factors influencing passenger car safety, International Journal of Crashworthiness 17(2): 217-232.
<http://dx.doi.org/10.1080/13588265.2011.648514>.
12. **William, T.; Hampton, C.; Scheldon, L.; Jamies, R.** 1999. Updated review of potential test procedures for FMVSS No. 208. Office of vehicle safety research, NHTSA. p. 122.
13. **Anindya, D.; Umesh, B.; Clifford, C.** 2008. HIC(d) Criterion and Headform Rotational Acceleration in Vehicle Upper Interior Head Impact Safety Assessment, SAE Paper No. 2008-01-0186.
14. **Cichos, D.; de Vogel, D.; Otto, M.; Shaar, O.; Zolsch, S.** 2006. Crash Analysis. Criteria description, p. 142. [online] [accessed 9 Oct.. 2012]. Available from Internet:
http://www.ni.com/pdf/products/us/crash_functions_descriptions.pdf.

J. Sapragonas, D. Juodvalkis, R. Makaras, R. Keršys

AUTOMOBILIO KĖBULO DAUGIAFUNKCIŲ DEFORMACINIŲ ZONŲ ELEMENTŲ TYRIMAS

Re z i u m ė

Automobilių pasyviosios saugos tyrimai, atliekami natūrinius susidūrimų su kliūtimis testus, yra sudėtingi ir brangūs, nes reikia didelių praktinių įgūdžių ir specialios įrangos. Tam tikrų deformacinės zonos elementų įtaką dinaminiam smūgio procesui galima pakankamai tiksliai iširti naudojant kelių masių dinaminis modelius. Darbe pateikta tokių modelių ir atskirų deformacinės zonos dalių charakteristikų aprašo sudarymo metodika. Sudarius tinkamą dinaminį modelį, kuriuo naudojantis gaunami rezultatai, adekvatūs natūrinių eksperimentų rezultatams, galima

greitai, nesudėtingai ir gana tiksliai nustatyti papildomai sumontuotų daugiafunkčių elementų įtaką automobilio saugai. Modeliavimo rezultatai parodė, kad automobilio priekyje įrengti papildomi putplasčio ar gumos elementai turi įtakos toliau esančių deformacinių zonų elgsenai ir smūgio proceso eigai. Papildomi elementai sugeria tam tikrą smūgio energijos dalį, sumažina toliau esančių deformacinių zonų pradinį deformavimo greitį ir jų sugieriamos energijos kiekį. Modeliuojant susidūrimą su kliūtimi skirtingais greičiais, pastebėta, kad papildomi elementai sušvelnina smūgio procesą.

J. Sapragonas, D. Juodvalkis, R. Makaras, R. Keršys

RESEARCH INTO ELEMENTS OF THE MULTIFUNCTIONAL DEFORMATION ZONES OF A CAR BODY

S u m m a r y

The studies of car's passive safety through car crash field tests are complicated and expensive as they require for significant practical skills and specific equipment. The effect of particular elements within deformation zones on the process of impact can be examined with sufficient precision using dynamic multi-mass models. This paper offers a methodology for development of the description of such models and individual parts of deformation zones. Having developed the appropriate dynamic model that is capable of delivering results adequate to those of field experiments, it is possible to simply and precisely assess the effect of additionally installed multifunctional elements on a car's safety. Simulation results showed that foam plastic or rubber elements additionally installed at the front of a car have the effect on behaviour of the subsequent deformation zones and course of the impact. Additional elements absorb a particular fraction of the impact energy, and reduce initial deformation speed of subsequent deformation zones and the amount of the energy absorbed by them. Simulation of the impact to barrier at different speeds resulted in observation that additional elements serve to mitigate the process of the impact.

Keywords: frontal deformation zone, dynamic model, absorbed energy.

Received Mai 17, 2012
Accepted April 08, 2013