

Circumferential stress concentration factors at the asymmetric shallow notches of the lifting hooks of trapezoidal cross-section

E. Narvydas*, N. Puodžiūnienė**

*Kaunas University of Technology, Kęstučio 27, 44312 Kaunas, Lithuania, E-mail: Evaldas.Narvydas@ktu.lt

**Kaunas University of Technology, Kęstučio 27, 44312 Kaunas, Lithuania, E-mail: Nomeda.Puodziuniene@ktu.lt

crossref <http://dx.doi.org/10.5755/j01.mech.18.2.1574>

1. Introduction

The stress concentration factors are widely used in strength and durability evaluation of structures and machine elements. A large number of research works have been performed in this field and recommendations for the engineers developed [1, 2]. However, the diversity of the loading cases, geometry and material characteristics together with the new solution methods motivates to continue the research, as it is proved by a large number of notch problem related publications that appeared during the last decade. The review of these and earlier publications allow to conclude that the specific group of the structural members, the curved beams, need a more extensive investigation since a very few articles in this field have been published yet (perhaps, there is the one and the only publication directly related to the stress concentration factors in curved beams due to the additional discontinuity of the geometry, the circular holes, under bending load [3]).

The present article continues the research work [4] on the modeling of the wear damage and its influence to the stress concentration for the lifting hooks of trapezoidal cross-section. The article provides a set of cases of the lifting hooks of trapezoidal gross cross-section with shallow notches, where the circumferential stress (σ_θ) concentration factors ($K_{t\theta}$) were calculated employing finite element analysis (FEA). The FEA results were grouped and fitted to find the equations suitable for the fast engineering evaluation of the notch effect on the stress concentration.

Some preliminary investigation of the stress triaxiality factors is also presented. The design rules of the lifting hooks require to use ductile materials to avoid brittle failure, however, the stress triaxiality reduces the ductility and the danger of brittle failure increases. In this respect, the strain based criteria for the failure prediction, accounting the stress triaxiality, appear to be more relevant.

2. Relevant load case and geometry

The design rules require to check stresses at two critical cross-sections of the curved part of the lifting hooks where the equivalent maximal stress should not exceed the allowed one [5]. These cross-sections are: 1st – on the horizontal plane and 2nd – on the vertical plane (depicted in Fig. 1). Only the second cross-section is considered here, because this cross-section most likely is subjected to the wear damage and a formation of the shallow notches. The loading scheme of the considered cross-section of the hook (Fig. 1, a) was applied assuming that the hook is loaded by two radial forces F_r . The assumed angle between these forces was: $2\alpha = 90^\circ$. The relation of

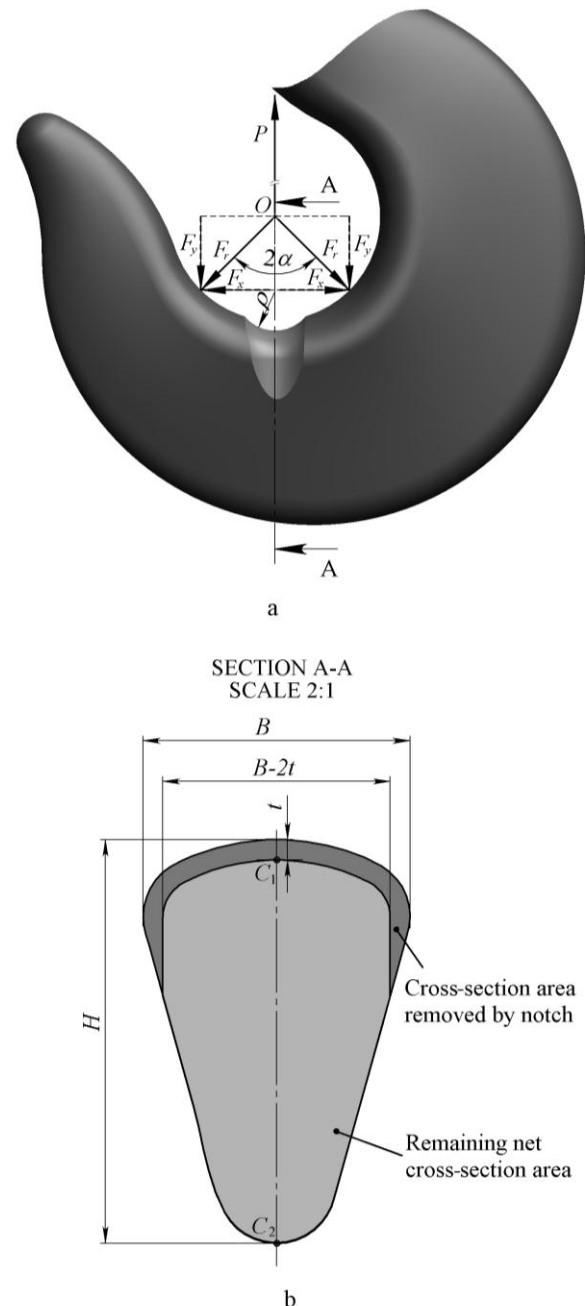

Fig. 1 Applied loading scheme and geometry of a notched lifting hook

F_r to the lifting force P is: $F_r = 0.5P/\cos\alpha$, the normal force acting on the cross-section and contributing to σ_θ is: $N = F_x = F_r \sin\alpha = 0.5Ptg\alpha$. The bending moment $M_c = N r_c = F_x r_c$. Here r_c is a distance from the center of curvature to the geometrical center of the cross-section.

The geometry of the trapezoidal cross-section with fillets was defined by the design standard for the industrial lifting hooks GOST 6627 -74 [6]. Two size cases of the hooks were considered: the case with cross-section height $H = 100$ mm and the case where $H = 82$ mm. The values of curvature (r_c/H) of the hooks for the section of interest was 0.975, when $H = 100$ mm, and 0.950, when $H = 82$ mm.

The notch was modeled as a groove of a circular profile that cuts the member along a perimeter of an upper part of the cross-section (Fig. 1) This groove forms a net cross-section under the notch. The range of t/ρ of the investigated cases was from 0.05 to 0.8; where t is a notch depth and ρ is a notch root radius. The notch geometry was modeled taking in to account the model of the possible wear of the lifting hooks [4].

3. Calculation of the circumferential stress concentration factors

The circumferential stress concentration factors were defined as ratios of maximal circumferential stresses and nominal circumferential stresses: $K_{t\theta} = \sigma_{\theta max} / \sigma_{\theta nom}$.

Evaluation of the maximal stresses at the notch root have been a significant problem to express analytically even under the elastic stress state. Experimental methods such as photoelastic or brittle coating and others were used for many years. At the present time the experimental techniques are partially replaced by the numerical methods since the computational hardware and software allows the precise modeling and very fine discretization of the notched geometry, sufficient for the correct determination of the maximal stresses. However, the experimental results and analytical expressions are still very important since they are necessary to validate the numerical models.

In the presented work the $\sigma_{\theta max}$ was calculated at the notch root on the vertical symmetry line of the notched cross-section (point C_1 in Fig. 1, b) using the FEA. The illustration of the generic finite element model, used in the analysis, is presented in Fig. 2. The models, consisting of the half of the geometry presented in Fig. 1, had the symmetry plane constraint and the fixed plane of the upper semicircular end. The three dimensional tetrahedral second order finite elements (e.g., element type SOLID187 in ANSYSTM software) were used to "mesh" the models with the appropriate refinement at the notch root. The elastic solution was performed using the mechanical properties of the low carbon steel 20 according to Russian standard GOST 1050-88 (equivalent to European steel C22E number: 1.1151, standard: EN 10083-2:2006) appointed for the production of the lifting hooks by standard GOST 2105-75 [7]. The Yong's modulus of this steel $E = 210000$ MPa and Poisson's ratio $\nu = 0.29$.

The nominal stresses usually are calculated employing common formulas of mechanics of materials for the structural members of uniform cross-section. For the curved beams, such as the lifting hooks, the most popular is the Winkler's equation [8]. According to this equation the $\sigma_{\theta nom}$ can be expressed as follows

$$\sigma_{\theta nom} = \frac{N}{A} + \frac{M_c y}{Aer} \quad (1)$$

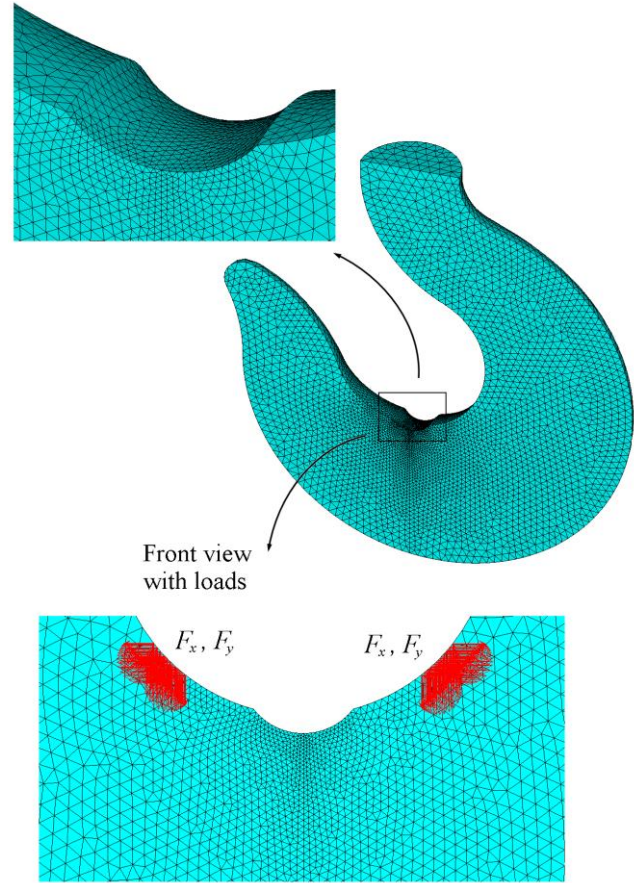

Fig. 2 Illustration of a generic 3D finite element model of a notched lifting hook

here A is the area of the cross-section; r is a radial coordinate of the point of interest having the origin at the center of member's curvature $y = r_n - r$ and $e = r_c - r_n$. The r_n is a distance from the center of curvature to the neutral axis of the cross-section in case of pure bending and is expressed by equation

$$e = \frac{A}{\int_A \frac{dA}{r}} \quad (2)$$

The area integral in Eq. (2) has a closed form solutions for regular shapes of the cross-section, e.g. circular, rectangular, trapezoidal etc. To calculate e for the non regular shapes, such as the presented notched cross-section, the numerical integration software was developed.

The Eq. (1) gives the results of an acceptable accuracy for many engineering cases. However, it usually underestimates the σ_{θ} at the points of cross-section that are close to the inner radius of curvature r_i , i.e. at the most significant location for the $K_{t\theta}$ calculation. The error depends on geometry of a curved beam and the ratio of N to M_c .

In order to obtain more accurate results at the points close to r_i , Cook suggested a correction of Winkler's equation [9]. According to this correction

$$\sigma_{\theta nom} = \frac{N}{A} \frac{r_n}{r} + \frac{M_c y}{Aer} \quad (3)$$

The other way to calculate $\sigma_{\theta nom}$ is to use a close

form solution of the theory of elasticity. However, the development of a practical solution is problematic. The known equations of Golovin (1881), for the contemporary engineers mostly known from the Timoshenko and Gudier textbook of elasticity [10], were derived assuming that the curved beam is of rectangular cross-section with the unit thickness. These equations are not suitable for the arbitrary shape of the cross-section. The derived equations suitable for the any shape of the cross-section of a curved beam [11] demonstrated a significant overestimation of the σ_θ at the points close to r_i comparing to the FEA results for the cross-section of the lifting hook [11].

Therefore, the FEA was applied to calculate the $\sigma_{\theta nom}$ in the presented study. The nominal circumferential stresses were calculated at the same point as the maximal ones, but in a curved beam of the uniform cross-section, i.e. the cross-sections of the notched members at the notch root and the cross-sections of the members without a notch were identical. In this way the stress concentration effect caused by the notch was separated from the stress concentration caused by the curvature of the member.

The distribution of the σ_θ along the vertical symmetry line ($C_1 C_2$) of the net cross-section of the smooth curved member is shown in Fig. 3 to illustrate the difference of the σ_θ results using different approaches: straight beam equation, Eqs. (1) and (2), and the FEA. The coordinate r of the graphs was normalized by the outside radius of curvature r_o and the σ_θ was normalized by the uniform normal stress $\sigma_n = N/A_{net}$. The nominal cross-section was constructed reducing the $H = 82$ mm by the notch depth $t = 4$. This figure also includes the results for the notched lifting hook with the notch root radius $\rho = 10$ mm, calculated by the FEA, to see the general notch effect on the σ_θ .

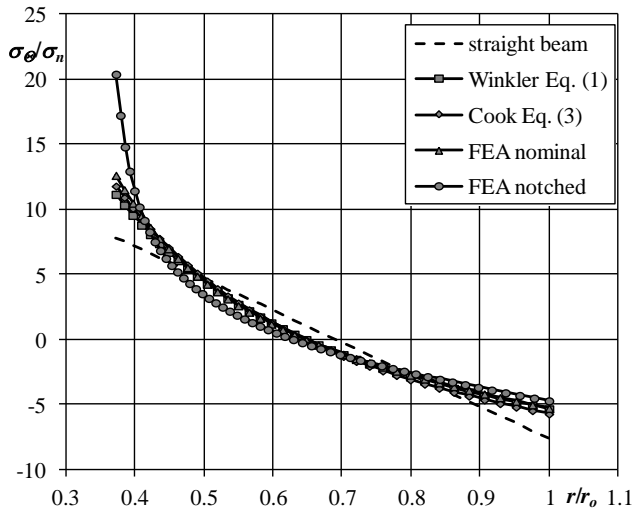

Fig. 3 Circumferential stress distribution along the symmetry line of the net cross-section of the smooth and notched lifting hook in the normalized coordinates

4. FEA results of the circumferential stress concentration factors and fitting curves

The results of $K_{t\theta}$ based on FEA of various sizes of lifting hooks and notches are presented in Figs. 4 and 5. These results were organized to form the separate sets regarding a different notch depth t and a cross-section height H . The values of $K_{t\theta}$ are presented as dependent on $\xi = t/\rho$,

and were fitted by equation

$$K_{t\theta} = a\xi^b + c \quad (4)$$

The fitting Eq. (4) represents a general form of Neuber's expression of K_t for the shallow notches [12]

$$K_t = 2\xi^{0.5} + 1 \quad (5)$$

The fitting results of Eq. (4) are shown by solid lines in Figs. 4 and 5, and the values of the fitted coefficients a , b and c are presented in Table. The analysis of the fitted coefficients allowed to conclude that for the small values of t/H , the fitted curves of $K_{t\theta}$ of the Eq. (3) are close to the offset curves of Eq. (5) and for the large t/H the additional factor regulating the curve slope is required. Therefore, it is possible to simplify the Eq. (4) by using the following assumed expressions

$$K_{t\theta} = 2\xi^{0.5} + c_f \quad (6)$$

if fitted c_f satisfies the condition $0.5 \leq c_f \leq 1.0$ and for the other cases

$$K_{t\theta} = (2\xi^{0.5} + 0.5) d_f \quad (7)$$

here c_f and d_f are the fitting coefficients; d_f may have values from 0 to 1.

The fitting results of Eq. (6) are graphically presented by the dashed curves and the results of Eq. (7) – by the dash-dot curves (Figs. 4, 5). The dotted curve represents the Neuber's Eq. (5). The values of the fitted coefficients c_f and d_f can also be found in Table.

The simplification of the Eq. (4) allows to find the expression of c_f and d_f for the fast engineering evaluation of the $K_{t\theta}$. It was assumed that values of the coefficients c_f and d_f depend on the geometrical parameters of the notched hook. Analysis of the results showed that c_f and d_f can be related to the ratio $\eta = t/H$ by certain functions $c_f = f_c(\eta)$ and $d_f = f_d(\eta)$. The functions f_c and f_d were expressed in a form of second order polynomial and fitted to c_f and d_f data (Fig. 6) giving the following expressions

$$c_f = 80.7\eta^2 - 16.72\eta + 0.983 \quad (8)$$

$$d_f = 48.3\eta^2 - 10.23\eta + 1.303 \quad (9)$$

The Eqs. (8) and (9) together with (6) and (7) allow to calculate the $K_{t\theta}$ for the notched lifting hook of any size and notch depth.

5. Stress triaxiality factors

There is a requirement for the production of the lifting hooks to use ductile materials such as the low carbon steel 20 after the thermal normalization, to avoid brittle failures. In addition, the welding procedures on the hook blanks are not allowed with the same purpose, to avoid the material embrittlement [7]. The violation of these rules can cause the dangerous failures [13].

However, the materials ductility, expressed as an equivalent plastic strain at failure, can be also reduced by the stress state triaxiality. In this respect the notch effect on the stress state triaxiality should be evaluated.

The Fig. 7 shows radial (σ_r) and axial (σ_x) stresses

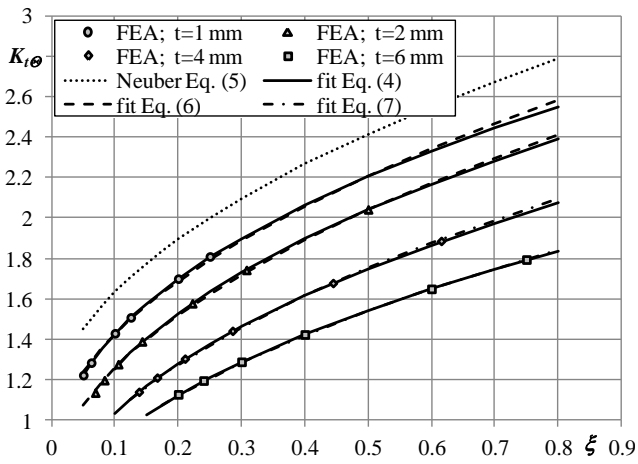

Fig. 4 Stress concentration factors $K_{t\theta}$ for the lifting hook of $H = 82$ mm with shallow notches

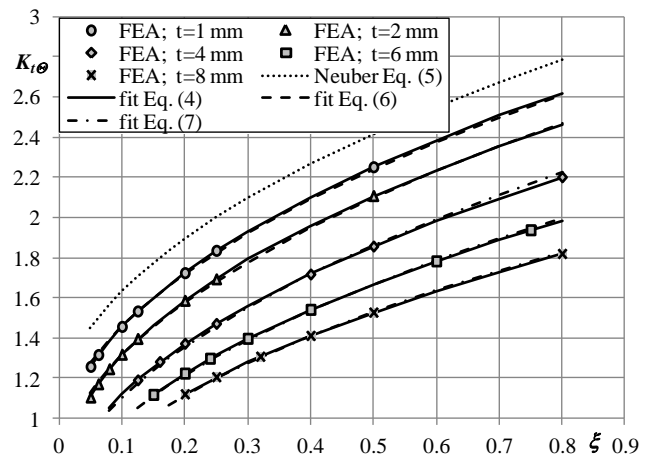

Fig. 5 Stress concentration factors $K_{t\theta}$ for the lifting hook of $H = 100$ mm with shallow notches

Table

Fitting data

Geometry		Fitted coefficients			Goodness of fit *			
H	t	a	b	c	R^2	R^2_{adjusted}	SSE	$RMSE$
equation (3)								
100	1	2.08	0.469	0.746	1.0000	1.0000	1.140E-5	0.001688
	2	2.13	0.432	0.524	0.9999	0.9998	9.504E-5	0.004360
	4	1.923	0.471	0.468	1.0000	1.0000	8.560E-6	0.001463
	6	1.760	0.4731	0.340	1.0000	1.0000	2.811E-6	0.0008382
	8	1.581	0.489	0.400	1.0000	1.0000	3.444E-6	0.001071
82	1	2.13	0.416	0.607	1.0000	0.9999	9.437E-6	0.001774
	2	2.13	0.424	0.451	0.9999	0.9999	3.801E-5	0.003083
	4	1.895	0.449	0.359	1.0000	1.0000	1.751E-6	0.000764
	6	1.612	0.489	0.391	1.0000	1.0000	5.378E-8	0.0001339
equations (5) and (6)								
H	t	c_f	d_f	R^2	R^2_{adjusted}	SSE	$RMSE$	
100	1	0.824	–	0.9992	0.9992	5.632E-4	9.689E-3	
	2	0.681	–	0.9985	0.9985	1.155E-3	1.285E-2	
	4	–	0.972	0.9981	0.9981	1.510E-3	1.586E-2	
	6	–	0.872	0.9995	0.9995	2.501E-4	6.456E-3	
	8	–	0.798	0.9994	0.9994	1.807E-4	6.011E-3	
82	1	0.792	–	0.9968	0.9968	8.535E-4	1.307E-2	
	2	0.624	–	0.9993	0.9993	4.618E-4	8.773E-3	
	4	–	0.914	0.9997	0.9997	1.208E-4	4.916E-3	
	6	–	0.804	0.9999	0.9999	3.827E-5	2.767E-3	

* R^2 – the coefficient of multiple determination; R^2_{adjusted} – the degrees of freedom adjusted R^2 ; SSE – the sum of squares due to error; $RMSE$ – the root mean squared error

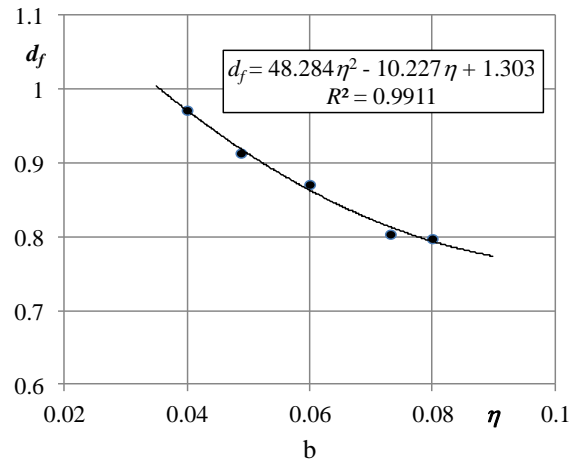
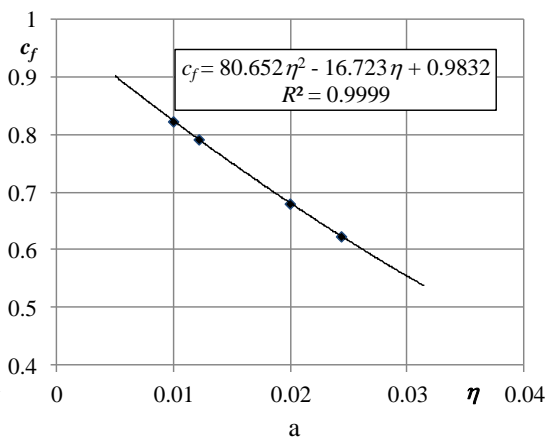

Fig. 6 Fitted coefficients c_f (a) and d_f (b) vs. geometric parameter $\eta = t/H$

along the symmetry line of the equal size net cross-sections of the smooth and notched lifting hook in the coordinates normalized to the outside radius of curvature r_o and uniform normal stress $\sigma_n = N/A_{net}$; the gross height of the hook cross-section $H = 82$ mm, notch depth $t = 4$ mm, notch root radius $\rho = 10$ mm.

The stress triaxiality factor (TF), initially proposed by Davis and Connely [14], is used to account the ductility reduction in many engineering cases [15]. It is defined as a ratio of the three times the hydrostatic pressure and the von Mises equivalent stress

$$TF = \frac{\sqrt{2}(\sigma_1 + \sigma_2 + \sigma_3)}{\sqrt{(\sigma_1 - \sigma_2)^2 + (\sigma_2 - \sigma_3)^2 + (\sigma_1 - \sigma_3)^2}} \quad (10)$$

here $\sigma_1, \sigma_2, \sigma_3$ are the principal stresses.

The Fig. 8 shows the TF distribution along the symmetry line of the net cross-section of the smooth and notched hook for the case of $H = 82$ mm,

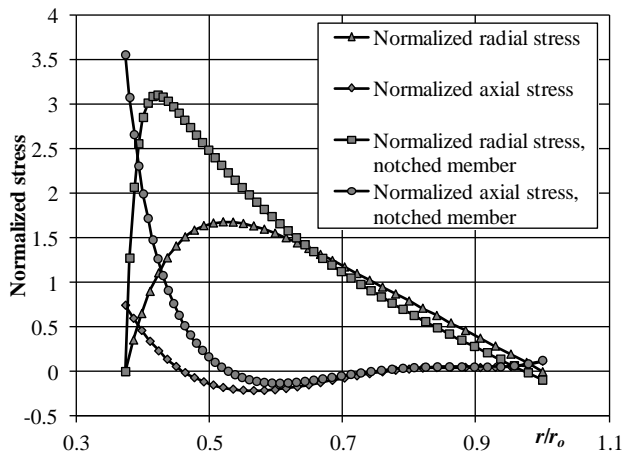

Fig. 7 FEA results of σ_r and σ_z distribution along the symmetry line of the net cross-section of the smooth and notched hook in the normalized coordinates ($H = 82$ mm, $t = 4$ mm, $\rho = 10$ mm)

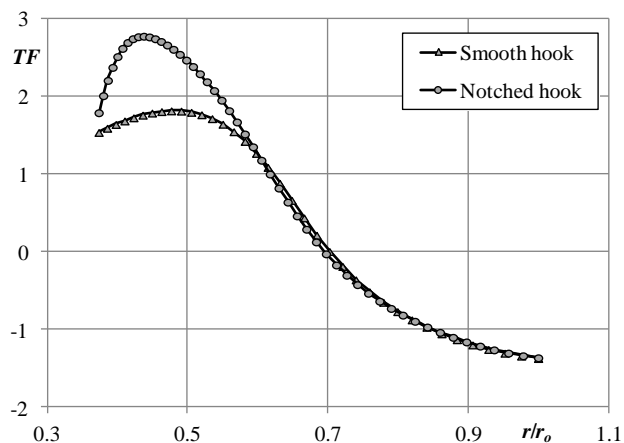

Fig. 8 Stress triaxiality factor along the symmetry line of the net cross-section of the smooth and notched hook ($H = 82$ mm, $t = 4$ mm, $\rho = 10$ mm)

$t = 4$ mm and $\rho = 10$ mm under the elastic stress state. As it is seen from the Fig. 8, the notch makes the stress triaxiality factor not only increases, but the maximum point is shifted toward the center of the members curvature, i.e.

toward the point of the maximal normal and equivalent stresses and creates an additional negative effect on safety of the curved member.

6. Conclusions

Formulas for the fast engineering evaluation of the stress concentration factors at the shallow notches of the lifting hooks of trapezoidal cross-section (GOST 6627-74) were established by fitting the selected generic equations to the FEA results. The difference of the results of the fitted equations comparing to the FEA results were in a range of 3% for the investigated cases.

The stress triaxiality factor contributing to the ductility reduction exceeds the unity (uniaxial stress state), for both smooth and notched hooks. However, for the smooth hook it is in a range between 1 and 2, while for the notched hook the top values are in a range from 2 to 3, that demonstrates the significant reduction of ductility at the inner surface of the curved part of the hook.

References

1. **Peterson, R.E.** 1974. Stress Concentration Factors. New York: John Wiley & Sons, Inc. 336 p.
2. **Pilkey, W.D.** 1997. Peterson's Stress Concentration Factors, 2nd ed. New York: John Wiley & Sons, Inc. 544 p.
<http://dx.doi.org/10.1002/9780470172674>.
3. **Paloto, J.C.; Santos, R.D.; Dominguez, P.** 2003. Stress concentration factors for a circular hole in curved beams under bending loads. Strain 39: 27-30.
<http://dx.doi.org/10.1046/j.1475-1305.2003.00042.x>.
4. **Narvydas, E.** 2010. Modeling of a crane hook wear and stress analysis. Transport Means 2010: Proceedings of the 14th international conference; 2010 Oct 21-22; Kaunas University of Technology, Lithuania. Kaunas: Technologija. 161-164.
5. **Pavlov, N.G.** 1976. Examples of the Integrity Calculations of the Cranes, 4th ed. Leningrad: Mashinostroenie. 320 p.(in Russian).
6. GOST 6627-74 1974. Single Hooks. Blanks. Types. Construction and Dimensions. Moscow: Publishing office of standards. 7 p. (in Russian).
7. GOST 2105-75 2004. Forged and Stamped Hooks. Specifications. Moscow: Publishing office of standards. 5 p. (in Russian).
8. **Young, W.C.; Budynas, R.G.** 2002. Roark's Formulas for Stress and Strain. 7th edition. New York: McGraw-Hill. 852 p.
9. **Cook, R.** 1992. Circumferential stresses in curved beams, Journal of Applied Mechanics-Transactions of the ASME 59: 224-225.
<http://dx.doi.org/10.1115/1.2899438>.
<http://dx.doi.org/10.1115/1.2899438>.
10. **Timoshenko, S.; Goodier, J.N.** 1970. Theory of Elasticity, 3rd ed. New York: McGraw-Hill. 567 p.
11. **Sloboda, A.; Honarmandi, P.** 2007. Generalized elasticity method for curved beam stress analysis: Analytical and numerical comparisons for a lifting hook, Mechanics Based Design of Structures and Machines 35: 319-332.
<http://dx.doi.org/10.1080/15397730701473820>.
12. **Neuber, H.** 1958. Kerbspannungslehre, 2nd ed. Berlin:

- Springer 207 p. (in German).
13. **Torres, Y.; Gallardo, J.M.; Dominguez J.; Jimenez, F.J.** 2010. Brittle fracture of a crane hook, *Engineering Failure Analysis* 17: 38-47.
<http://dx.doi.org/10.1016/j.engfailanal.2008.11.011>.
 14. **Davis, E.A.; Connelly, F.M.** 1959. Stress distribution and plastic deformation in rotating cylinders of strain-hardening material, *Journal of Applied Mechanics-Transactions of the ASME* 26: 25-30.
 15. **Snow, S.D.; Morton, D.K.; Pleins, E.L.; Keating, R.** 2010. Strain-based acceptance criteria for energy-limited events. *ASME Pressure Vessels and Piping Conference, Operations, Applications and Components*, Vol. 7: 91-96.

E. Narvydas, N. Puodžiūnienė

TRAPECINIO SKERSPJŪVIO KĖLIMO KABLIŲ
APSKRITIMINIŲ ĮTEMPIŲ KONCENTRACIJOS TIES
ASIMETRINIAIS PAVIRŠINIAIS GRIOVELIAIS
KOEFCIENTAI

Re z i u m ė

Straipsnyje pateikiamos formulės apskritiminių įtempių koncentracijos koeficientams apskaičiuoti. Jos sudarytos aproksimuojant įtempių kabliuose su negiliu paviršiniu grioveliu analizės rezultatus, gautus baigtinių elementų metodu. Aproksimacijai panaudota apibendrinta Neuberio formulė įtempių koncentracijos ties negilia įpjova cilindrinėse ir plokščiose detalėse koeficientams skaičiuoti. Pateiktas ir supaprastintas formulės variantas, sudarytas naudojant tik vieną aproksimacijos koeficientą. Gautas išraiškos leidžia greitai nustatyti apskritiminių įtempių koncentraciją nenaudojant baigtinių elementų modelio.

Straipsnyje taip pat pateikiamas preliminarus įtempių būvio erdviškumo tyrimas; įvertintas jo sukeltas kablių medžiagos plastiškumo sumažėjimas ties paviršiniu grioveliu.

E. Narvydas, N. Puodžiūnienė

CIRCUMFERENTIAL STRESS CONCENTRATION
FACTORS AT THE ASYMMETRIC SHALLOW
NOTCHES OF THE LIFTING HOOKS OF
TRAPEZOIDAL CROSS-SECTION

S u m m a r y

The paper presents the equations for the calculation of the circumferential stress concentration factors. The equations were obtained by fitting to the finite element analysis results of the lifting hooks with the shallow notches. The Neubers expression of the stress concentration factors at the shallow notches for the cylindrical beams and plates have been used as a generic fitting equation. The constructed simplified version of this equation, having just one fitting coefficient, is also presented. These equations allow to perform the fast evaluation of the circumferential stress concentration without the usage of the finite element models. The article also presents the preliminar investigation of the stress state triaxiality and the consequent reduction of the materials ductility at the shallow notches of the lifting hooks.

Keywords: lifting hook, curved beam stress analysis, stress concentration factors, FEA.

Received May 25, 2011
Accepted April 12, 2012