

## Energy Conversion Processes Research of Inverter – Three Phase Dual System Converter

**P. Balciunas, P. Norkevicius**

*Department of Electric Power Systems, Faculty of Electrical and Control Engineering, Kaunas University of Technology, e-mails: povilas.norkevicius@ktu.lt, povilas.balciunas@ktu.lt*

**crossref** <http://dx.doi.org/10.5755/j01.eee.120.4.1443>

### Introduction

Now days energy power sources are synchronous generators at thermal power plants whose use oil products or nuclear fuel, hydro and wind power plants [1]. These generators have low resistance of inductor windings and termed as voltage sources. Their current strength depends on only load resistance value. Here primary parameter is voltage, secondary is current. However electrical and magnetic expression duality is known for a long. Therefore there are created machines whose generates electric power according to electromagnetic induction law whose current strength is constant at electrical circuit and voltage depends on load resistance. Such electrical machines had high internal resistance and termed as current sources. Here primary parameter is current, secondary is voltage. Ideal voltage source is active element of electrical circuit which internal resistance is equal to zero and therefore voltage value is constant ( $U=const.$ ) and does not depend on load current strength ( $I=var.$ ) [2, 3]. Ideal current source is active element of electrical circuit which internal resistance is infinite. Therefore current strength value is constant ( $I=const.$ ) and does not depend on load voltage, which varies ( $U=var.$ ) independently on load resistance value [2, 3]. High power electro mechanic current sources are not utilized at electric power engineering sector. Though static current sources are utilized more widely at modern technologies, alternative and renewable power engineering sector [3, 4]. Nuclear electric power generator is one of the promising utilized alternative current sources at power engineering. Their operations are based on nuclear fuel radiation conversion to electrical energy directly [3, 4]. Today some fuel cells convert hydrogen energy directly to electrical power whose are utilized at modern electrical power engineering sector [5]. They can be termed as modern static, high, power current sources according to output characteristic  $I=f(U)$  [5, 9]. Solar power is one of the developing renewable energy sources mostly at renewable energy source field. Current source is

photovoltaic converter at solar power plant which consists from semiconductor photo element which converts solar ray energy to electric power directly.

Current sources are used at such modern technologies as solid state lasers, electro thermal metal welding, illumination and irradiation of gas discharge lamps equipments.

Electric power converters are used as current sources at today technologies whose converts standard parameters and frequency (50 Hz, 60 Hz) electric power to current source energy [6, 8]. Presented information shows that electric power voltage at current sources are used at complex circuits and create voltage source ( $U=const.$ ,  $I=var.$ ) or current source ( $I=const.$ ,  $U=var.$ ) dual systems.

Application of current source systems create unique possibility to utilize, huge resource stochastic character, low potential electric power of renewable energy sources.

### The processes theory of inverter – three phase dual system converter

The inverter – three phase dual system converter (ITSC) is used to convert DC electric power of voltage system to three phases, steady frequency AC electric power of current system. Here is used nonlinear, active, inductive, capacitive and semiconductor elements system. Simulation-mathematical modeling method is used for electric power conversion research [3]. ITSC model diagram is showed at picture Fig. 1. Here  $U_0$  – DC voltage of voltage system electric power which varies stochastically.  $k1 - D1$ ,  $k2 - D2$ ,  $k3 - D3$ ,  $k4 - D4$ ,  $k5 - D5$ ,  $k6 - D6$  is thyristor (transistor) of separate phases and semiconductor diodes imitators of ITSC,  $L_{k1} - C_{k1}$ ,  $L_{k2} - C_{k2}$ ,  $L_{k3} - C_{k3}$  – reactive elements,  $C_{01}$ ,  $C_{02}$  – capacitors whose store DC energy. Load elements are following:  $R_{15}$ ,  $R_{16}$ ,  $R_{17}$  – autonomous three phase load or (and) standard three phase source (eg. synchronous generator), whose emf  $E_1$ ,  $E_2$ ,  $E_3$  RMS values and they variation laws are known.  $R_{18}$ ,  $R_{19}$ ,  $R_{20}$  – internal resistances of each emf. Oriented

graph of ITSC electrical diagram is formed for electromagnetic processes research and equation creation. 9 diagram nodes (O), 21 diagram branches (□) are showed at oriented graph. There are created topological matrixes of branch, node, loop of electrical diagram. These matrixes are used for node and loop equations creation. Such equations are selected that all system generalized structural mathematical model could be created possibly simpler [6, 7].

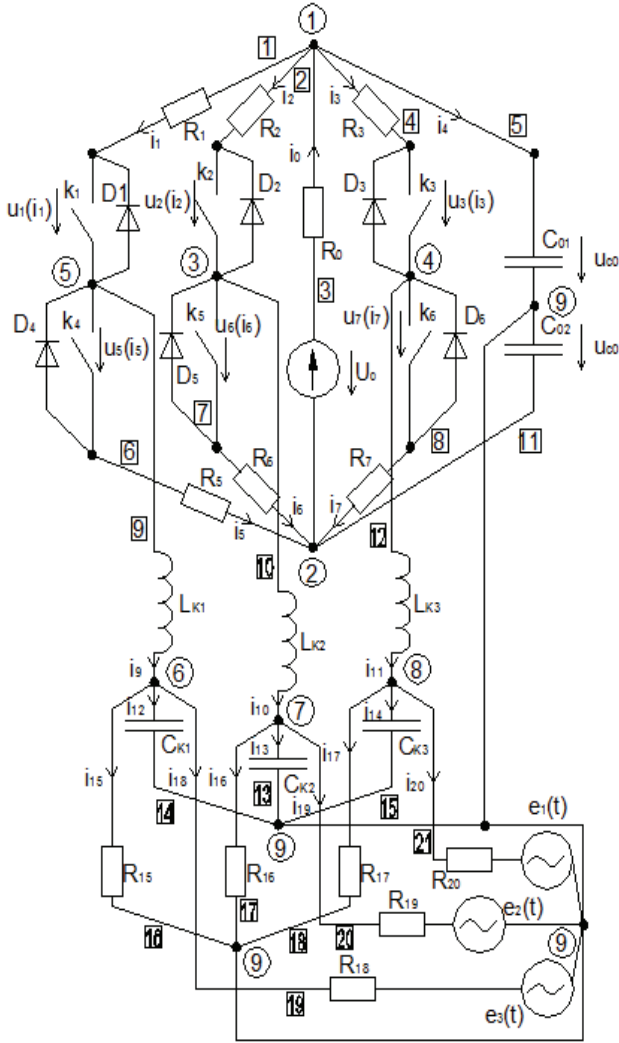
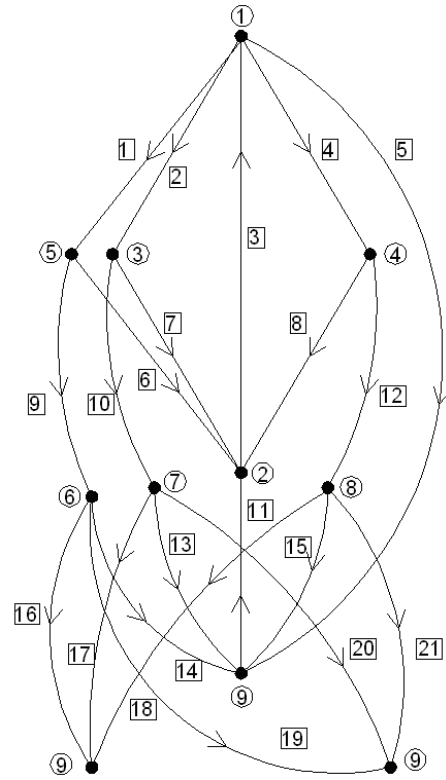

**Fig. 1.** Electrical diagram of ITSC for simulation – mathematical modeling research

Equations number is selected such that mathematical model corresponded to ITSC electrical diagram fully. Differential equations are transformed to Koshi form. Some equations are transformed that there would remain only one parameter derivative [6, 7].

### Electromagnetic processes differential equations

Initial parameters of calculation are following at ITSC mathematical model structure:  $U_0, R_1, R_2, R_3, R_5, R_6, R_7, C_{01}, C_0, L_K, C_{K1}, L_{K2}, C_{K2}, L_{K3}, C_{K3}, R_{15}, R_{16}, R_{17}, R_{18}, R_{19}, R_{20}, E_1, E_2, E_3$ . Calculation results of equations are electrical values:  $i_1, i_2, i_3, i_4, i_5, i_6, i_7, i_8, i_9, i_{10}, i_{11}, i_{12}, i_{13}, i_{14}, i_{15}, i_{16}, i_{17}, i_{18}, i_{19}, i_{20}$ .



**Fig. 2.** Oriented graph of electrical diagram of ITSC for simulation – mathematical modeling research

Equations Koshi form for model is following:

$$\frac{du_{C01}}{dt} = \frac{1}{C_{01}} \cdot i_0 - \frac{1}{C_{01}} \cdot i_1 - \frac{1}{C_{01}} \cdot i_2 - \frac{1}{C_{01}} \cdot i_3, \quad (1)$$

$$\frac{du_{C02}}{dt} = \frac{1}{C_{02}} \cdot i_5 + \frac{1}{C_{02}} \cdot i_6 + \frac{1}{C_{02}} \cdot i_7 - \frac{1}{C_{02}} \cdot i_0, \quad (2)$$

$$i_{10} = i_2 - i_6, \quad (3)$$

$$i_{11} = i_3 - i_7, \quad (4)$$

$$i_9 = i_1 - i_5, \quad (5)$$

$$\frac{du_{CK1}}{dt} = \frac{1}{C_{K1}} \cdot i_9 - \frac{1}{C_{K1}} \cdot i_{15} - \frac{1}{C_{K1}} \cdot i_{18}, \quad (6)$$

$$\frac{du_{CK2}}{dt} = \frac{1}{C_{K2}} \cdot i_{10} - \frac{1}{C_{K2}} \cdot i_{16} - \frac{1}{C_{K2}} \cdot i_{19}, \quad (7)$$

$$\frac{du_{CK3}}{dt} = \frac{1}{C_{K3}} \cdot i_{11} - \frac{1}{C_{K3}} \cdot i_{17} - \frac{1}{C_{K3}} \cdot i_{20}, \quad (8)$$

$$i_0 = \frac{U_0}{R_0} - \frac{R_6}{R_0} \cdot i_6 - \frac{1}{R_0} \cdot u_6(i_6) - \frac{R_2}{R_0} \cdot i_2 - \frac{1}{R_0} \cdot u_2(i_2), \quad (9)$$

$$i_3 = \left( \frac{R_0}{R_3} \cdot i_0 + \frac{1}{R_3} \cdot u_3(i_3) + \frac{R_7}{R_3} \cdot i_7 + \frac{1}{R_3} \cdot u_7(i_7) \right) + \frac{U_0}{R_3}, \quad (10)$$

$$i_5 = \frac{U_0}{R_5} - \frac{1}{R_5} \cdot u_5(i_5) - \frac{R_1}{R_5} \cdot i_1 - \frac{R_0}{R_5} \cdot i_0 - \frac{1}{R_5} \cdot u_1(i_1), \quad (11)$$

$$\frac{di_9}{dt} = \frac{R_5}{L_{k1}} \cdot i_5 - \frac{1}{L_{k1}} \cdot u_5(i_5) - \frac{1}{L_{k1}} \cdot u_{CK1} - \frac{1}{L_{k1}} \cdot u_{C0}, (12)$$

$$\frac{di_{11}}{dt} = \frac{R_7}{L_{k3}} \cdot i_7 + \frac{1}{L_{k3}} \cdot u_7(i_7) - \frac{1}{L_{k3}} \cdot u_{C02} - u_{CK3}, (13)$$

$$u_{C01} = U_0 - u_{C02} - R_0 \cdot i_0, (14)$$

$$i_{15} = \frac{1}{R_{15}} \cdot u_{CK1}, (15)$$

$$i_{16} = \frac{1}{R_{16}} \cdot u_{CK2}, (16)$$

$$i_{17} = \frac{1}{R_{17}} \cdot u_{CK3}, (17)$$

$$i_{18} = \frac{1}{R_{18}} \cdot u_{CK1} - \frac{1}{R_{18}} \cdot e_3(t), (18)$$

$$i_{19} = \frac{1}{R_{19}} \cdot u_{CK2} - \frac{1}{R_{19}} \cdot e_2(t), (19)$$

$$i_{20} = \frac{1}{R_{20}} \cdot u_{CK3} - \frac{1}{R_{20}} \cdot e_1(t). (20)$$

Functional converters – semiconductor simulators structures are showed in Fig. 3 [3, 6].

Here pulse period of control oriented of functional converters – semiconductor is  $T_{pulse}=0,02 s$  and pulse angle of corresponding transistor:  $\psi_{k1}=0^0$ ;  $\psi_{k2}=120^0$ ;  $\psi_{k3}=240^0$ ;  $\psi_{k4}=180^0$ ;  $\psi_{k5}=300^0$ ;  $\psi_{k6}=420^0$ .

Matlab, Simulink software is used for solution of equation. It is possible to research any purpose and power ITSC electromagnetic processes by entering known initial parameters to model according technical specification. ITSC mathematical description is used for research results analysis and creation of ITSC engineering methodology.

Here are presented characteristics of specific electrical values.

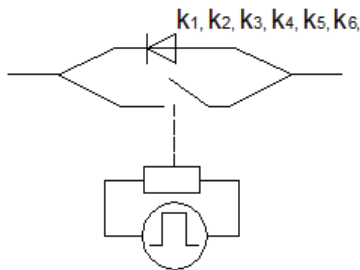

Fig. 3. Structures of functional converters – semiconductor simulators

### Research results of electromagnetic processes of energy conversion

At this section are presented research results of conversion of stationary and transient electromagnetic

processes of ITSC autonomous operating conditions, electrical network operating condition.

Research results of autonomous operating condition is performed when three phase load is symmetrical therefore resistances of load are equal and  $R_{15}=R_{16}=R_{17}$ . One of three phase load current  $I_{15}$  dependence on load  $R_{15}$  is presented at Fig. 4, because variation is identical of currents  $I_{16}$ ,  $I_{17}$ . ITSC converted current  $I_{15}$  has very high stability factor  $\gamma$  at wide range of load  $R_{15}$  variation. When load resistance varies from  $10 \Omega$  to  $400 \Omega$ , then  $U_0=12 V$ ,  $\gamma = \pm 4,6\%$ ;  $U_0=36 V$ ,  $\gamma = \pm 12,5 \%$ ;  $U_0=60 V$ ;  $\gamma = \pm 12,6 \%$ .

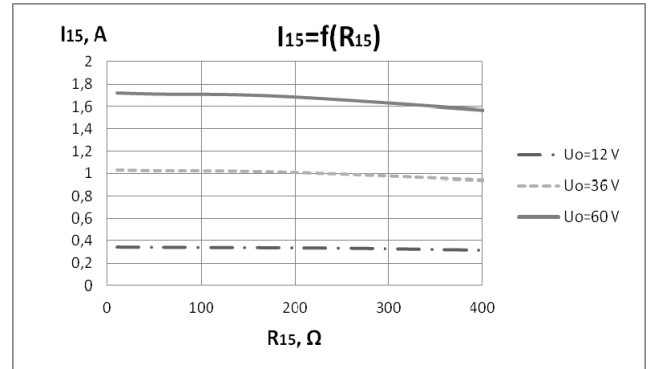

Fig. 4. Current  $I_{R15}$  dependence on load resistance  $R_{15}$ ,  $I_{R15} = f(R_{15})$

Input current of ITSC  $I_0$  dependence on load resistances  $R_{15}$ ,  $R_{16}$ ,  $R_{17}$  are presented at Fig. 5. Research results shows when load resistances  $R_{15}$ ,  $R_{16}$ ,  $R_{17}$  varies 40 times input voltage of ITSC:  $U_0=12 V$ ,  $I_0$  varies 35,8 times;  $U_0=24 V$ ,  $I_0$  varies 34,9 times;  $U_0=36 V$ ,  $I_0$  varies 33,6 times and  $I_0$  varies linearly. Research results presented at Fig. 4 and Fig. 5 confirmed that ITSC operates according electric power system dualism concept and converts DC electrical energy of voltage power system ( $U = \text{const. } I = \text{var.}$ ) to three phase current power system ( $I = \text{const. } U = \text{var.}$ ) and transmit to three phase load.

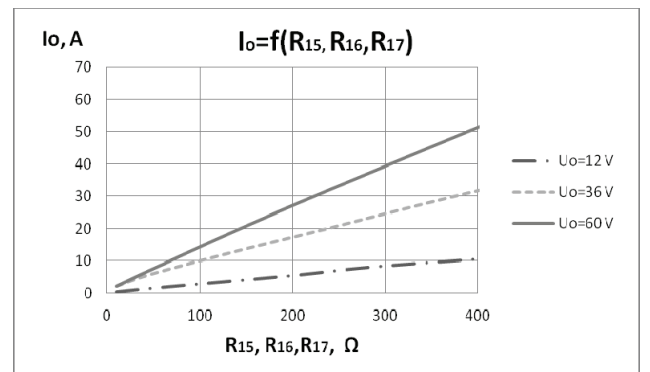
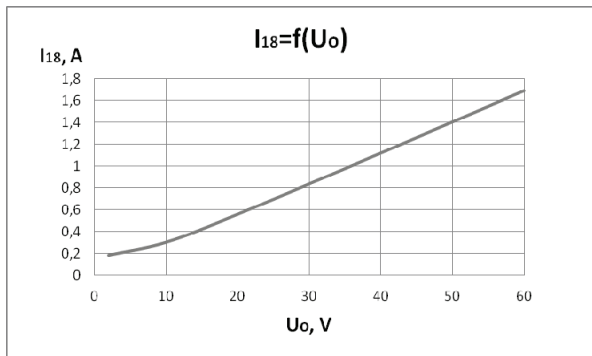

Fig. 5. Input current of ITSC  $I_0$  dependence on load resistance  $R_{15}$ ,  $R_{16}$ ,  $R_{17}$ ,  $I_0 = f(R_{15}, R_{16}, R_{17})$

Research results of electrical network operating condition is performed when three phase electrical network voltage of phase to earth is  $E_1=E_2=E_3=230 V$  and internal resistances of are equal  $R_{18}=R_{19}=R_{20}=0,01 \Omega$ . One of transmitted current  $I_{18}$  to electrical network dependence on voltage  $U_0$  is presented in Fig. 6 because variation is identical of currents  $I_{19}$ ,  $I_{20}$ . In Fig. 6 shown that when  $U_0$

varies 30 times then transmitted current to electrical network  $I_{18}$  varies 9,17 times and linearly. Research results shows that stochastic character ITSC input electrical energy is converted by ITSC and transmitted to three phase electrical network permanently.



**Fig. 6.** Current  $I_{18}$  transmitted to electrical network dependence on voltage  $U_o$ ,  $I_{18} = f(U_o)$

Fig. 7 shows transmitted currents  $i_{18}$ ,  $i_{19}$ ,  $i_{20}$  by ITSC to electrical network time  $t$  function,  $i_{18}$ ,  $i_{19}$ ,  $i_{20} = f(t)$ . ITSC load current is periodic functions whose frequency is 50 Hz. There is evaluated rank of harmonics of currents  $i_{18}$ ,  $i_{19}$ ,  $i_{20}$  transmitted electrical to network by ITSC. Modeling is performed when ITSC input voltage value is  $U_o = 20$  V and three phase electrical network voltage,  $U_S = 230$  V. Modeling is performed by following methodology.

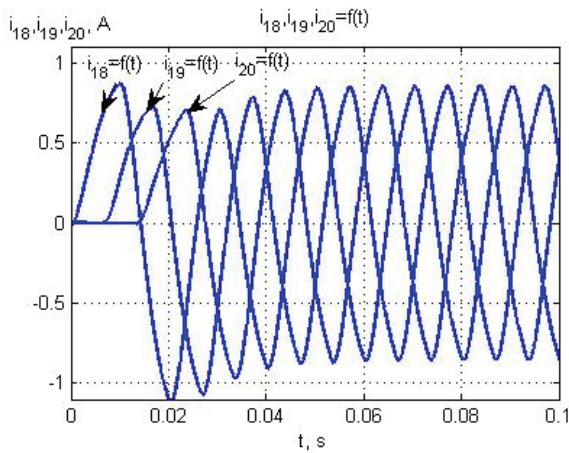

**Fig. 7.** Current to electrical network  $i_{18}$ ,  $i_{19}$ ,  $i_{20}$  time  $t$  function  $i_{18}$ ,  $i_{19}$ ,  $i_{20} = f(t)$

The magnitude of the selected harmonic component is calculated by the following equations

$$I_n = \sqrt{a_n^2 + b_n^2}, \quad (21)$$

where  $n$  – number of selected harmonic,  $a_n$  and  $b_n$  – amplitudes of harmonics.

$a_n$  and  $b_n$  calculated by following equations:

$$a_n = \frac{2}{T} \cdot \int_0^T f(t) \sin(n\omega t) dt, \quad (22)$$

$$b_n = \frac{2}{T} \cdot \int_0^T f(t) \cos(n\omega t) dt. \quad (23)$$

Number of harmonic components of electrical network currents  $I_{18}$ ,  $I_{19}$ ,  $I_{20}$  and showed at Fig. 8.

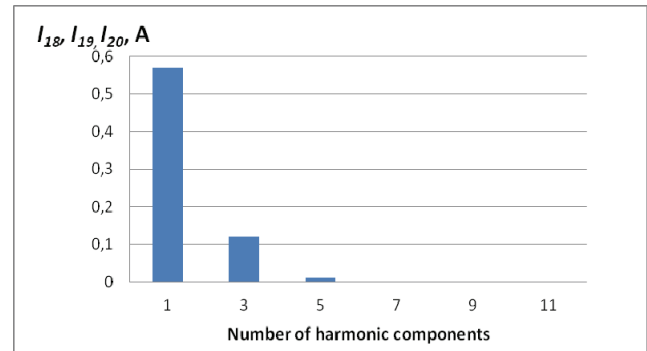

**Fig. 8.** Number of harmonic components of electrical network currents  $I_{18}$ ,  $I_{19}$ ,  $I_{20}$

Research results show that percentage value of fundamental component harmonic is equal to 81%, third harmonic percentage is equal 17%, third harmonic percentage is equal 1%, higher than 5th harmonics percentage is less than 1% and for each phase percentage values are identical. Therefore fundamental component of harmonic structure of electrical network currents  $I_{18}$ ,  $I_{19}$ ,  $I_{20}$  whose is transmitted from ITSC to electrical network is dominating. ITSC converts stochastic character DC electrical energy to high quality AC electrical energy which is transmitted to electrical network.

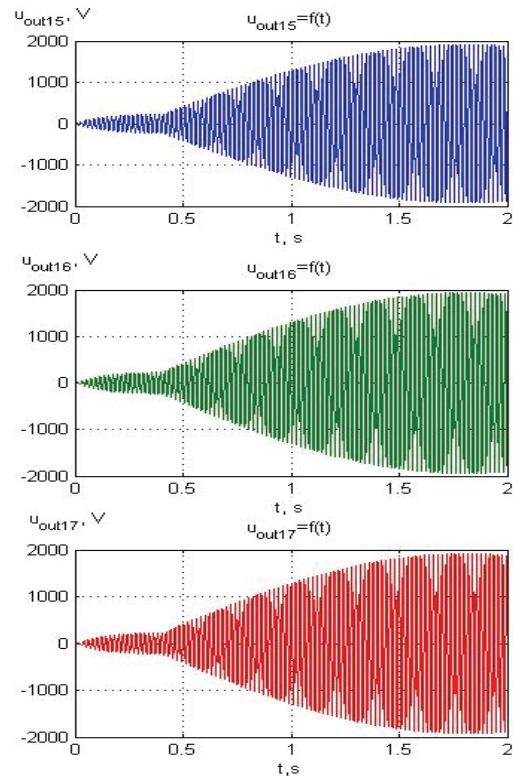

**Fig. 9.** Output voltage  $u_{out15}$ ,  $u_{out16}$ ,  $u_{out17}$  of ITSC dependence on time  $t$

Transient electromagnetic processes research results of autonomous operating condition are showed at Fig. 9. and Fig. 10.

Fig. 9 shows open circuit operation of ITSC research results. Here is showed output voltage between phases and earth  $u_{out}$  dependence on time  $t$ ,  $u_{out15}, u_{out16}, u_{out17} = f(t)$ . Here three phase load resistance  $R_{15}, R_{16}, R_{17}$  are disconnected from ITSC at time  $t = 0,4$  s, when  $U_0 = 20$  V,  $R_{16}, R_{17}, R_{18} = 300 \Omega$ . Results shows that after  $t > 0,5$  s,  $u_{out15}, u_{out16}, u_{out17}$  peak values increase to 105 times. Here transient process duration is 1,25 s.

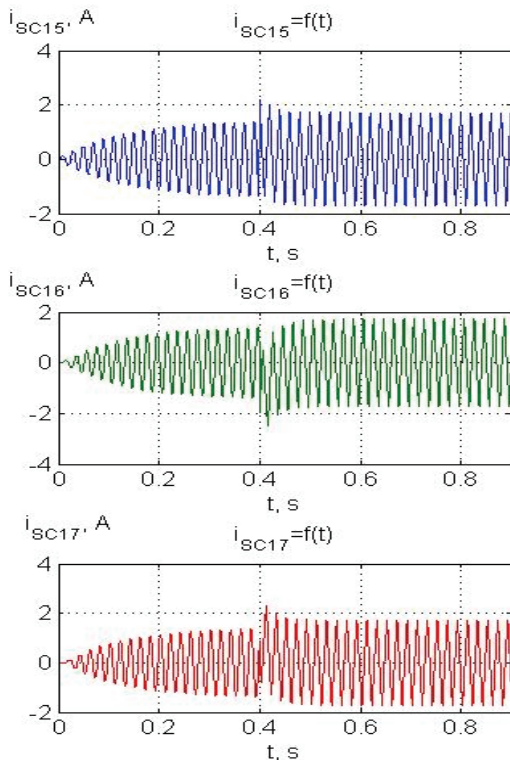

**Fig. 10.** Three phase load resistances  $R_{15}, R_{16}, R_{17}$  short circuit current  $i_{sc15}, i_{sc16}, i_{sc17}$  dependence on time  $t$

Fig. 10 shows three phase load resistance short circuit electromagnetic transient processes results. Here  $R_{15}, R_{16}, R_{17}$  is short circuited on time  $t = 0,4$  s. Results shows that after  $t > 0,4$  s peak value of ITSC output current  $i_{sc15}, i_{sc16}, i_{sc17}$  increases up to only 3,4 times but this value is near rated current value. Here transient process duration is 0,08 s. Modeling results of transient processes of ITSC open circuit operation shows that such operating condition could be hazardous for conversion system practically.

## Conclusions

1. Research results confirmed possibility of voltage system ( $U_0 = const., I_0 = var.$ ) electric power conversion to current system ( $U_{15, 16, 17} = var., I_{15, 16, 17} = const.$ ) electric power of selected ITSC structure and ITSC operates at inverter – three phase dual system converter.
2. Three phase current  $I_{15}, I_{16}, I_{17}$ , value does not depend on corresponding three phase load resistances  $R_{15}, R_{16}, R_{17}$ , variation significantly. When load  $R_{15}$  varies 40 times and ITSC input voltage  $U_0$  varies 3 time currents stability factor  $\gamma$  varies up to  $\pm 12,6 \%$ .

3. When stochastic character ITSC voltage  $U_0$  of input of electric power varies 20 times electric power is converted and transmitted by ITSC to three phase electrical network permanently.
4. Electrical network current harmonic percentage of fundamental component is equal to 81%, therefore quality is high of stochastic character electric power converted by ITSC without any filter and transmitted to electrical network.
5. Modeling research results of electromagnetic transient processes of conversion shows when ITSC operates at open circuit operation ITSC output voltage  $u_{out}$  increases up to 105 times therefore such operation could be hazardous practically.
6. Mathematical modeling research results of electromagnetic transient processes shows when ITSC load is short circuited peak value of ITSC output current  $i_{sc}$  increases up to only 3,4 times but this value is near rated current value.
7. Applied mathematical modeling methodology for ITSC allows researching its electromagnetic stationary and transient processes of energy conversion, storage, transmission and mathematical model of ITSC log all time functions of variables and various values of parameter, analyses influence of element parameters to other elements.

## References

1. **Balčiūnas P., Adomavičius V.** Renewable Energy Conversion Problems and their Solving Methods // Electronics and Electrical Engineering. – Kaunas: Technologija, 1999. – No. 4(22). – P. 67–72.
2. **Balčiūnas, Povilas, Norkevičius, Povilas.** Stochastic nature electrical energy conversion processes experimental research of wind micro power plant // Electronics and Electrical Engineering. – Kaunas: Technologija, 2010. – No. 9(105). – P. 57–60.
3. **Balčiūnas P.** Dual Electric systems circuit theory and application. Science monography. – Kaunas: Technologija, 2011. – 194 p.
4. **Tetzlaff K. H.** The better way to energy economy without emission. – P.H.S., 2001. 122 p.
5. **Process development for hydrogen generation systems.** – Deutesches Centrym fur Luft und Raumfahrt, Hanovver Messe, 2006. – 1 p.
6. **Norkevičius P.** Wind micro power plant electric power system conversion and energy storage processes research (doctoral dissertation). – Kaunas, 2010. – 122 p.
7. **Norkevičius P.** Mathematical modeling of inverter – system converter // Proceedings of the 5th international conference on electrical and control technologies (ECT'2010). – Kaunas University of Technology, 2010. – P. 285–288.
8. **Norkevičius P., Balčiūnas P.** Lietuvos valstybiniam patentų biurui prašymas išduoti patentą. – Elektros sistemų dualizmo būdas ir įrenginys stochastinei energijai konvertuoti. – IP-1/98 forma. 2010.04.29.
9. **Balčiūnas P.** Chemotroninės mikroelektroninės konceptualiosios studijos tyrimas // 5 – tosios tarptautinės konferencijos Elektros ir valdymo technologijos ECT-2010 straipsnių rinkinys. – Kaunas: Technologija, 2010. – P. 9–12.

Received 2011 12 06  
Accepted after revision 2012 02 01

**P. Balčiūnas, P. Norkevičius. Energy Conversion Processes Research of Inverter – Three Phase Dual System Converter // Electronics and Electrical Engineering. – Kaunas: Technologija, 2012. – No. 4(120). – P. 9–14.**

Current sources are used at modern technologies widely. These technologies are solid state laser storage, electro thermal metal welding, gas discharge lamps lighting and irradiation equipment. Application of current source system creates unique possibilities to use low potential, stochastic character electrical energy of renewable energy resources site more effectively. Research results and practical application possibilities of electrical energy conversion processes of inverter – three phase dual system converter are presented at paper. Such three phase inverter – system converter could be applied effectively at renewable energy site. III. 10, bibl. 9 (in English; abstracts in English and Lithuanian).

**P. Balčiūnas, P. Norkevičius. Trifazio inverterio – dvigubosios sistemos energijos keitiklio konversijos procesų tyrimas // Elektronika ir elektrotechnika. – Kaunas: Technologija, 2012. – Nr. 4(120). – P. 9–14.**

Moderniosiose technologijose plačiai naudojami srovės šaltiniai yra kietojo kūno lazerių kaupimo, elektroterminio metalų suvirinimo, dujų švytelių lempų ir švitinimo įrenginiai. Naudojant srovės šaltinio sistemas darniosios energetikos srityje, susidaro unikalios galimybės gerokai efektyviau nei iki šiol naudoti žemo potencialo, tačiau didelių išteklių atsinaujinančiųjų energijos šaltinių stochastinio pobūdžio elektros energiją. Straipsnyje pateikiami trifazio inverterio, kurį galima efektyviai pritaikyti darniojoje energetikoje, dvigubosios sistemos energijos keitiklio konversijos procesų tyrimo rezultatai, aptariamos praktinio taikymo galimybės. II. 10, bibl. 9 (anglų kalba; santraukos anglų ir lietuvių k.).