

Capacity and Handover Analysis in Mobile WiMAX

E. Kacerginskis, L. Narbutaite

Department of Telecommunications, Kaunas University of Technology,

Studentu st. 50, LT-51368 Kaunas, Lithuania, e-mails: lina.narbutaite@ktu.lt, eugenijus@ntservice.eu

crossref <http://dx.doi.org/10.5755/j01.eee.119.3.1357>

Introduction

The Mobile WiMAX (Worldwide Interoperability for Microwave Access) is a wireless access technology standardized by Institute of Electrical and Electronics Engineers and WiMAX forum. The IEEE802.16e standard was developed from the previous IEEE802.16-2004 release of WiMAX. Important amendment in IEEE 802.16e is the support for handover (HO) and the multiple access technique OFDMA (Orthogonal Frequency Division Multiple Access). Depending on the level of received signal, distance from base station (BS), type of modulation and sub-carriers permutation customers have different data throughput. It enables to implement different types of services together with different quality of services (QoS). Other important aspect is influence of handover on user traffic parameters. The objective of this work is to analyze the capacity of mobile WiMAX in the case of different modulation schemes and to evaluate handover scanning impact on registration throughput and time, including cell and handover traffic blocking probability.

Analysis of mobile WiMAX capacity

The IEEE 802.16e air interface is based on OFDMA the main goal of which is to give better performance in non-line-of-sight (NLOS) environments. The PHY (physical layer) features of IEEE 802.16e include scalable OFDMA to carry data supporting channel bandwidth (BW) between 1.25MHz and 20MHz using up to 2048 sub-carriers [1–3]. WiMAX uses two different types of modulation techniques: QAM and QPSK. WiMAX uses these modulations to give best performance in different environmental conditions. BS dynamically selects the modulation scheme depending on interference in signals and distance to the user. The level of received signal (RSS) and the distance from base station affects selection of the modulation schemes and data rate (R). When the link quality is high, WiMAX uses highest order modulation with highest coding scheme that increases the system

capacity. If the signal needs to be sent a long distance and is affected by fading, WiMAX can easily move to the lower order modulation with lower coding scheme.

In a mobile WiMAX the distributed sub-carriers has different types of permutation (Table 1). The frame supports different types of sub-carriers permutations in both downlink (DL) and uplink (UL) sub-frames.

Table 1. WiMax subcarriers permutation types

Permutation type	Link type
Partial usage of sub channelization (PUSC)	DL/ UL
Full usage of sub channelization (FUSC)	DL
Adaptive modulation and coding (AMC)	DL/ UL

The total data rate of physical downlink depends on the type of permutation. Therefore at first it is necessary to evaluate influence of different modulation and permutation types on data rate. Only two permutation types - PUSC and AMC - were analyzed, because only they are used in both link directions. For evaluation of network capacity and investigation of handover parameters, the network planning and handover calculation software was developed [3]. This software includes: the estimation of sector coverage, calculation of data throughputs for available modulation types, planning of distances to base station, calculations of the overlapping zones and estimation of the handover generated throughput (Fig.1 and Fig.2). It enables to simulate protocol which is used during handover process when mobile station roams between base stations. Also it can be used for simulation of any other wireless protocols. The software enables to set desired latency at each network node, the size of the messages and the error probability. The software possess user friendly interface for calculation of the mobile WiMAX network planning parameters and provides the recommendations for highest

coverage and lowest investment ratio. Also it enables to simulate the procedures of WiMAX handover “hand-shaking” protocols, estimates unused radio capacity and handover performance.

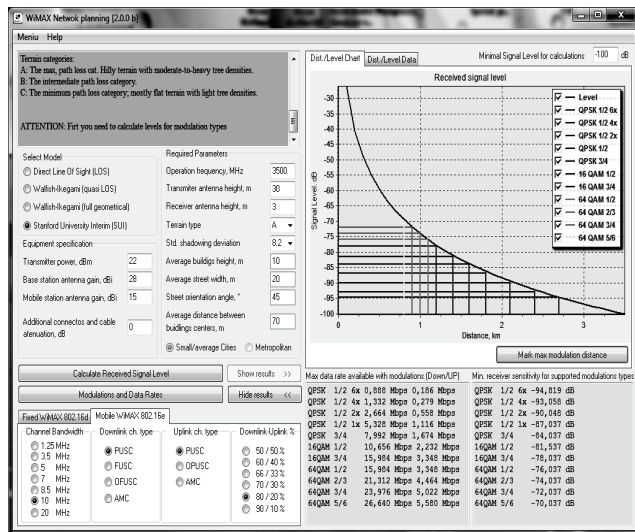

Fig. 1. The software window “WiMAX network planning”

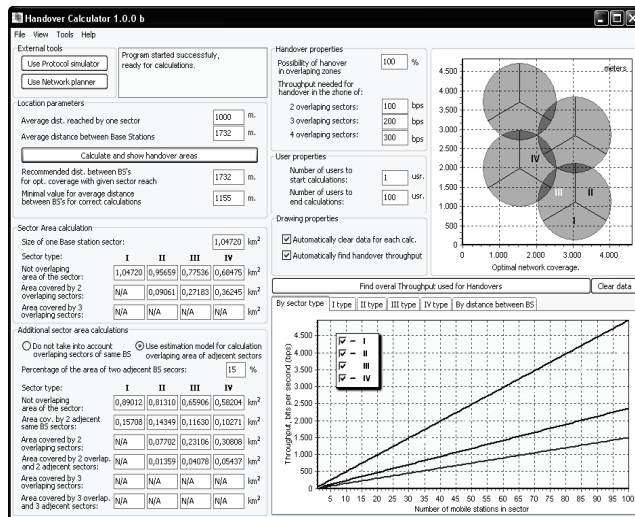

Fig. 2. The software window “Handover calculator”

The developed software was used for analysis of mobile WiMAX performance. The set-up data for modelling are given in Table 2.

At first the influence of modulation and sub-carriers permutation types of data rate was investigated using development software and obtained results are presented in Fig. 3 and Fig. 4.

As can be seen when very high data rates are required for a given bandwidth the 16-QAM and the 64-QAM modulations are used.

Table 2. The parameters used for estimation of date rate and received signal level

Parameter	Value
Transmitter power, dBm	23
Base station antenna gain, dBi	12
Base station antenna gain, dBi	9
Frequency, MHz	3500
Propagation model	SUI, Terrain type A

Parameter	Value
Channel bandwidth, MHz	5
Minimal signal level dB	-100
Downlink/uplink ratio	80/20

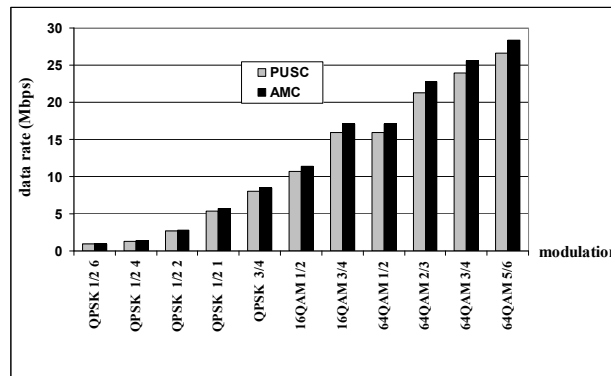

Fig. 3. Downlink data rate versus modulation in the case of different sub-carriers permutation types

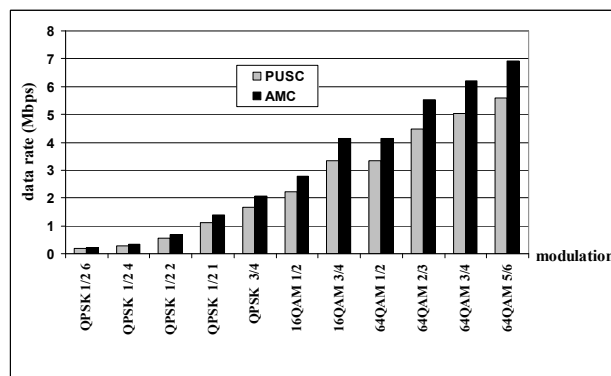

Fig. 4. Uplink data rate versus modulation in the case of different sub-carriers permutation types

64-QAM supports up to 28 Mbps peak data transfer downlink and up to 7Mbps – uplink, when only 5 MHz channels are used. The dependencies of the signal level and the modulation type on distance base station were investigated in the next step of modelling. The calculations are based on SUI type A radio propagation model, which is used for non-line of sight environments with high level of obstacles on of the path signal. It can represent a city center with high building density.

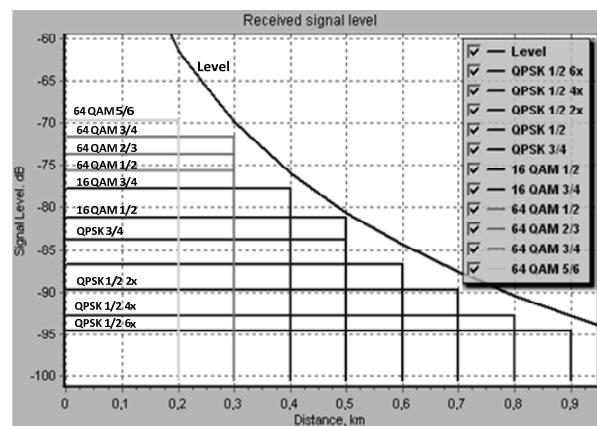

Fig. 5. The signal level versus distance in the case of different modulation types with PUSC sub-carriers permutation

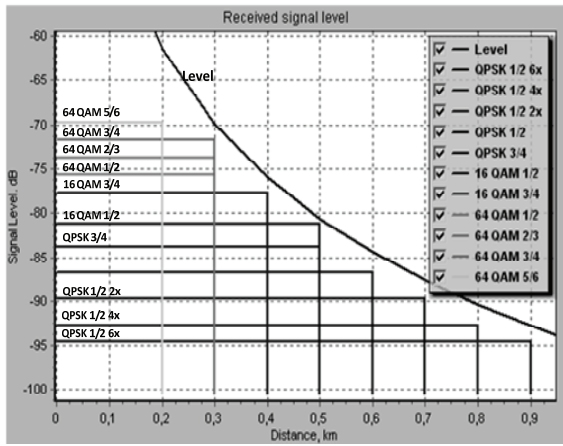

Fig. 6. The level of signal versus distance in the case of different modulation types with AMC sub-carriers permutation

The modulation is more sensitive to inter-symbol interference and noise if bigger number of bits per symbol is used. In general the signal-to-noise ratio (SNR) determines the modulation method to be used for the signal transmission. QPSK is more tolerant to interference than 16-QAM or 64-QAM. Due to this reason QPSK is the better choice, in the case when signals are should be resistant to noise and other distortions caused by transmission over long distances. The AMC have bigger number of data sub-carriers therefore the data rate is higher than of the PUSC. However the PUSC ensure better performance of radio quality, because the number of available data subcarriers is lower and the number of pilot sub-carriers is higher than the AMC.

Analysis of mobile WiMAX handover

The handover is most important factor in WiMAX. Two major types of HO are defined in the network: the Hard Handover (HHO) and the Soft Handover (SHO). The Hard Handover is default handover and not uses any additional schemes. The Soft Handover is optional procedure and uses two handover schemes: Macro Diversity handover (MDHO) and Fast Base Station Switching (FBSS). The HO process is initiated depending on the Relative Signal Strength (RSS) at the Serving Base Station (SBS) and at the Target Base Station (TBS). In the case when the RSS at the SBS drops below a predefined threshold, the Mobile Station MS goes for a handover with one of the chosen neighbour BSs (NBS). The handover procedure is presented in the Fig. 7 Using protocol simulation software influence of WiMAX handover procedure to the data traffic was investigated. The studies are carried out in two stages: in the first stage the handover scanning procedure was analyzed; in the second one the actual re-registration procedure was simulated in the case when user is moving between base stations. Calculations take in to account the number of base stations that are available for handover procedure and the quality of wireless channel (packet loss probability).

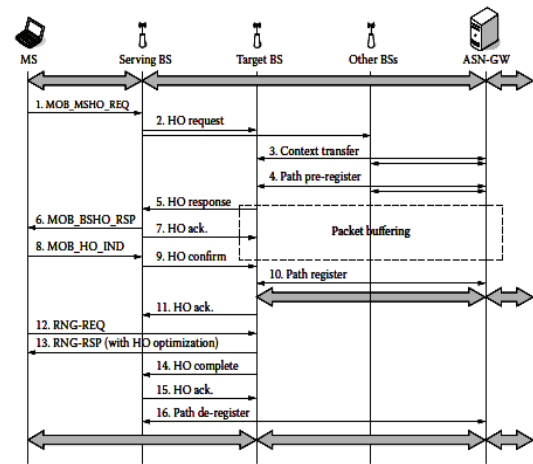

Fig. 7. Handover procedure [4]

Obtained results of throughput generated by simulation of scanning procedure are presented in Fig.8 and Fig. 9. The throughputs obtained taking into account different number of the base stations and the packet loss ratio during modelling of the re-registration procedure are presented in Fig. 10 and Fig.11.

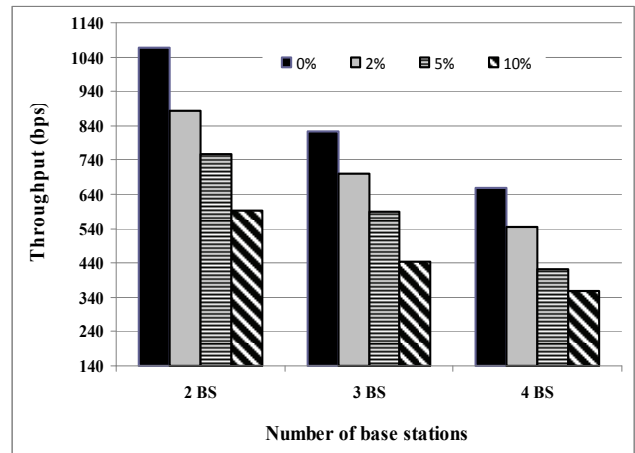

Fig. 8. The scanning downlink throughput versus number of BS in the case of different packet loss ratio

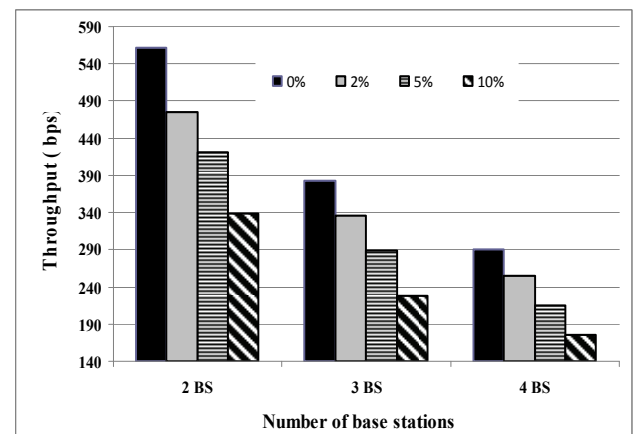

Fig. 9. The scanning uplink throughput versus number of BS in the case of different packet loss ratio

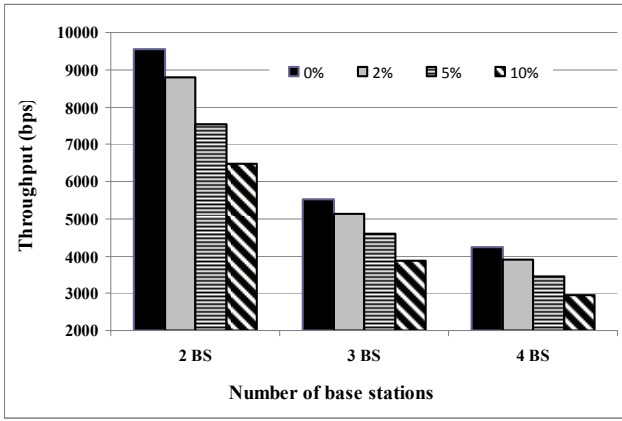

Fig. 10. Registration downlink throughput versus number of BS in the case of different packet loss ratio

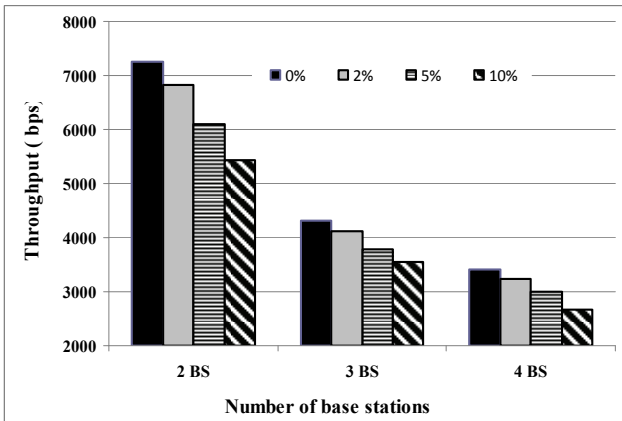

Fig. 11. Registration uplink throughput versus number of BS in the case of different packet loss ratio

As can be seen, the data load generated by handover scanning is negligible in comparison with HO procedure. The handover traffic of one mobile station varies from 3 to 9.5 kbps for downlink and from 2.5 to 7 kbps for uplink depending on different packet loss ratio.

In the case of only two overlapping sectors with 25-75 mobile stations the handover throughputs was varying in the ranges of 50 to 130 kbps for downlink and 40 to 120 kbps for uplink, when the 5 MHz channel are used with 2% packet loss, 50% handover probability at sector edges.

Assuming that handover procedure is continuous process and it is performed by every mobile station that has more than one BS in coverage, basic HO procedure creates significant impact on network capacity, especially at sector edges, where lowest modulation and lowest data throughput are available (Fig. 12). As can be seen, the data flow (throughput) generated by HO decreases with increase of the number of base stations or packet loss ratio. This can be explained by the fact that in presence of the big number of BS more time is spend for registration procedures, as consequence less time is spend for generation of data requests and this leads to reduction of the generated by HO data flow in the network.

Also it can be seen that the handover registration time essentially depends on packet loss ratio and the number of base stations, with which the mobile station communicates during the registration.

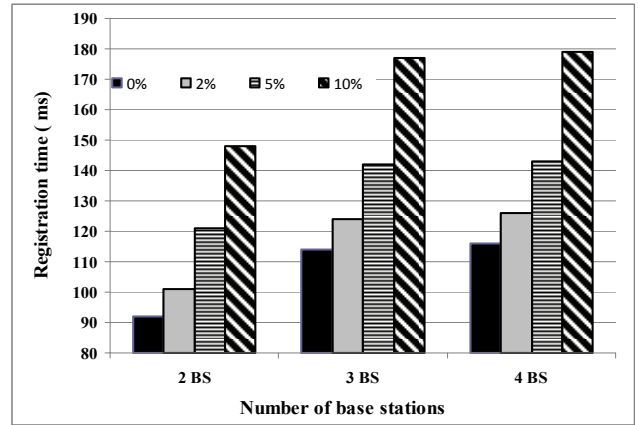

Fig. 12. Registration time versus number of BS in the case of different packet loss ratio

The handover latency varies from 92ms up to 180 ms. In the case of non-real-time service packet delay and packet delay fluctuations is not important and the user will not feel the negative effects of re-registration procedures. For real-time services (VoIP, video) the re-registration delay greater than 80 ms creates a negative impact on voice quality. Therefore for real time service is better to use another type of handover (FBSS or MDHO). The comparison of the number of handovers in HHO and FBSS is presented in Fig 13.

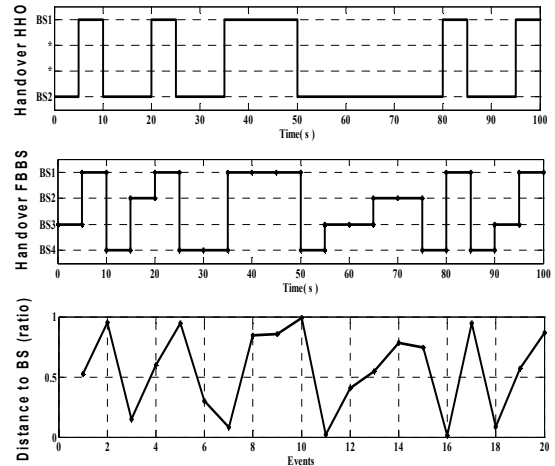

Fig. 13. The number of handovers from one BS to another one

The diversity set in FBSS is the group of base stations to one of which the MS is ready to switch. In FBSS the mobile user communicates only with the anchor base station, but the MS still maintains a set of base stations; the MS can quickly switch anchors to one of these base stations without having to go through the entire HHO process.

One of the main parameters for evaluation of handover performance is the traffic blocking probability. From the viewpoint of user's, forced termination of handover call is considerably less desirable than blocking of a new call. Therefore design of an efficient channel assignment scheme is very important. For evaluation of this parameter three schemes of channel assignment are used: without

priority, with priority and with buffer (Fig. 14). Two type of traffic: cell and handover are analyzed in the network.

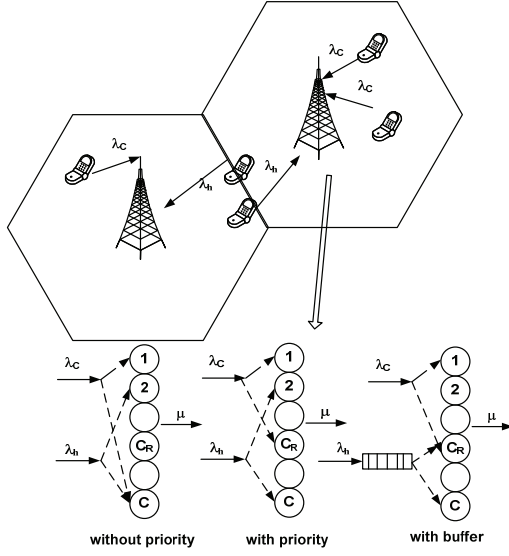

Fig. 14. Three schemes of channel assignment

The traffic blocking probability was investigated using Markov chain. Each state, in the Markov chain represents the number of occupied channels [5,7]. All traffics are assumed to follow a Poisson arrival process with mean rates λ_c and λ_H . They have exponential distribution of service time with mean rate $\frac{1}{\mu}$. The total number of channels is C and $C_H=C-C_c$ of which are prioritized channels used only for handover traffic, C_c is the number of the reserved channels.

In the case of scheme of channel assignment without priority, the steady-state probabilities are calculated by [5, 7]

$$P(j) = \frac{(\lambda_c + \lambda_H)^j}{j! \cdot \mu^j} \cdot P(0), \quad \text{if } 0 \leq j \leq C, \quad (1)$$

$$P(0) = \left[1 + \sum_{j=1}^C \left(\frac{\lambda_c + \lambda_H}{\mu} \right)^j \cdot \frac{1}{j!} \right]^{-1}, \quad (2)$$

where λ_c , λ_p is the arrived intensity of cell and handover traffic, μ is the traffic service intensity.

Then the blocking probabilities of the cell and the handover traffic are given by

$$Pb_c = Pb_H = P(C). \quad (3)$$

In the case, when priority scheme of the channel assignment is used the steady-state probabilities are calculated by

$$P(j) = \begin{cases} \frac{(\lambda_c + \lambda_H)^j}{j! \cdot \mu^j} \cdot P(0), & \text{if } 0 \leq j \leq C_c, \\ \frac{(\lambda_c + \lambda_H)^{C_c} \cdot \lambda_H^{j-C_c}}{j! \cdot \mu^j} \cdot P(0), & \text{if } C_c \leq j \leq C, \end{cases} \quad (4)$$

where

$$P(0) = \left[\sum_{j=0}^{C_c} \frac{(\lambda_c + \lambda_H)^j}{j! \cdot \mu^j} + \sum_{j=C_c+1}^C \frac{(\lambda_c + \lambda_H)^{C_c} \cdot \lambda_H^{j-C_c}}{j! \cdot \mu^j} \right]^{-1}. \quad (5)$$

The expression for calculation of the blocking probability of cell traffic is

$$Pb_c = \sum_{j=C_c}^C P(j). \quad (6)$$

The blocking probability of handover traffic can calculate using equation

$$Pb_H = P(C) = \frac{(\lambda_H + \lambda_c)^{C_c} \cdot \lambda_H^{C-C_c}}{C! \cdot \mu} \cdot P(0). \quad (7)$$

When the buffer scheme of channel assignment is used the steady-state probabilities are found as follows

$$P(j) = \begin{cases} \left(\frac{\lambda_c}{\mu} \right)^j \cdot \frac{1}{j!} \cdot P(0), & \text{if } 0 \leq j \leq C_c, \\ \frac{(\lambda_c)^{C_c} \cdot \lambda_H^{j-C_c}}{j! \cdot \mu^j} \cdot P(0), & \text{if } C_c \leq j \leq C, \\ \frac{(\lambda_c)^{C_c} \cdot \lambda_H^{j-C_c}}{C! \cdot \mu^C \prod_{i=1}^{j-C} (C \cdot \mu + i\mu_1)} \cdot P(0), & \text{if } C < j < C+Q, \end{cases} \quad (8)$$

where

$$P(0) = \left[1 + \sum_{j=0}^{C_c} \left(\frac{\lambda_c}{\mu} \right)^j \cdot \frac{1}{j!} + \sum_{j=C_c+1}^C \frac{(\lambda_c)^{C_c} \cdot \lambda_H^{j-C_c}}{j! \cdot \mu^j} + \sum_{j=C+1}^{C+Q} \frac{(\lambda_c)^{C_c} \cdot \lambda_H^{j-C_c}}{C! \cdot \mu^C \prod_{i=1}^{j-C} (C \cdot \mu + i\mu_1)} \right]^{-1}. \quad (9)$$

The expression of the blocking probability of cell traffic calculation is

$$Pb_c = \sum_{j=C_c}^{C+Q} P(j). \quad (10)$$

The blocking probability of handover traffic can be calculated using following equation

$$Pb_H = \sum_{j=C_c}^{C+Q} P(j) \cdot P(T > T_p). \quad (11)$$

The results obtained are shown in Fig. 16 and Fig. 17. As can be seen for handover traffic is better to use channel assignment scheme with buffer. In this case the blocking probability is in the order 10^{-2} .

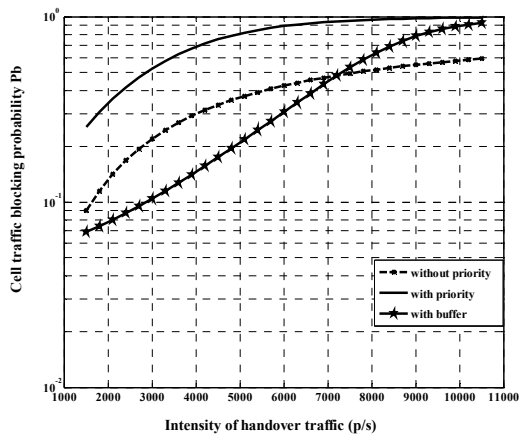

Fig. 15. Blocking probability of cell traffic versus intensity of handover traffic in case of different channel assignment schemes

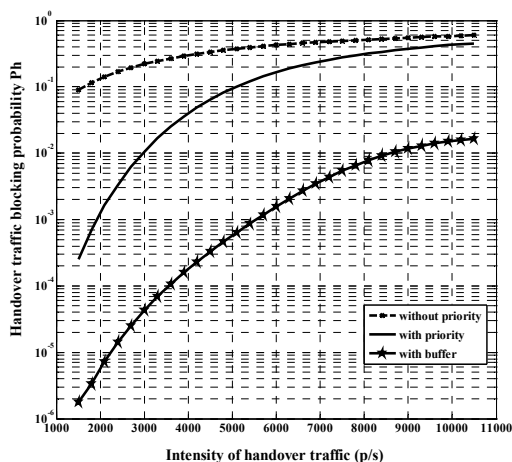

Fig. 16. Blocking probability of handover traffic versus intensity of handover traffic in case of different channel assignment schemes

When without priority channel assignment scheme is used this parameter is 0.59. For cell traffic, when handover traffic intensity is low, the channel assignment scheme with buffer is best to use. However, when handover traffic intensity is high, then the cell traffic blocking probably is smaller in the case of channel assignment scheme without

priority comparing to channel assignment scheme with buffer.

Conclusions

As the result of carried out investigation of mobile WiMAX capacity and handovers it can be stated, that:

- The optimized handover does not causes very high data loads, however detailed network resource planning must be done in growing networks, in order to avoid situations where the high number of mobile stations per sector can significantly decrease sector capacity in overlapping areas at the edges of the sectors;
- AMC have bigger number of data subcarriers therefore the data rate is higher than of PUSC. However PUSC has better performance of radio quality ;
- For handover traffic servicing on the BS is better to use channel assignment scheme with buffer because the blocking probably is smallest.

References

1. **Yan Zhang.** WiMAX network planning and optimization. – Taylor & Francis Group, LLC, 2009. – 443 p.
2. **Dalal U. D., Kosta Y. P.** WIMAX, New Developments. – 2009. – 450 p.
3. **Wang F., Ghosh A., Sankaran Ch.** Mobile WiMAX Systems: Performance and Evolution // IEEE Communications Magazine, 2008. – P. 41–49.
4. **Rehmani N. F.** Time Domain Efficient Handoff Scheme for Mobile WiMAX. Australian Journal Of Basic And Applied Science, 2011. – No. 5(8). – P. 1135–1150.
5. **Tung D., Wong Ch.** Wireless broadband networks. – John Wiley & Sons, Inc., 2009. – 514 p.
6. **Alatise M., Mzyece M., Kurien A.** A Handover Scheme for Mobile WiMAX Using Signal Strength and Distance. – 2009. – 6 p.
7. **Stojmenovic I.** Handbook of Wireless Networks and Mobile Computing. – Wiley & Sons, Inc., 2002. – 648 p. DOI: 10.1002/0471224561.

Received 2011 10 12

Accepted after revision 2011 12 01

E. Kacerginskis, L. Narbutaitė. Capacity and Handover Analysis in Mobile WiMAX // Electronics and Electrical Engineering. – Kaunas: Technologija, 2012. – No. 3(119). – P. 23–28.

This article analyzes mobile WiMAX network capacity and handover impact on characteristics of network QoS – sector capacity and service latency. Author designed software that was used for: sector capacity calculation for different modulation and subcarrier permutation techniques; handover simulation, evaluating generated data traffic dependencies from packet loss ratio and number of base stations. Mathematical equations were used for calculating regular and handover traffic blocking probability dependencies from traffic intensity for different channel assignment and prioritization algorithms. Ill. 16, bibl. 7, tabl. 2 (in English; abstracts in English and Lithuanian).

E. Kačerginskis, L. Narbutaitė. Mobiliojo WiMAX tinklo pralaidumo ir perkelties analizė // Elektronika ir elektrotechnika. – Kaunas: Technologija, 2012. – Nr. 3(119). – P. 23–28.

Analizuojamas mobiliojo WiMAX tinklo pralaidumas ir perregistravimo (perkelties) procedūros įtaka tinklo kokybinėms charakteristikoms – sektoriaus talpai ir paslaugų vėlinimui. Naudojantis autorių sudaryta programine įranga apskaičiuota mobiliojo WiMAX sektoriaus talpa esant skirtingoms moduliacijoms bei nešlių išdėstymo schemoms, atliktas mobiliojo WiMAX tinklo perkelties procedūrų modeliavimas, įvertinant sukuriamų duomenų srautų bei vėlinimo priklausomybę nuo paketų praradimo tikimybės ir bazinių stočių skaičiaus. Remiantis matematinėmis išraiškomis apskaičiuota įprasto ir perkelties procedūrų duomenų srauto blokavimo tikimybės priklausomybė nuo srauto intensyvumo naudojant skirtingus kanalo prioriteto priskyrimo algoritmus. Il. 16, bibl. 7, lent. 2 (anglų kalba; santraukos anglų ir lietuvių k.).