

Information Transmission Availability in WDM Networks

R. Plėštys

*Department of Computer Networks, Kaunas University of Technology,
Studentų str. 50, LT- 51368 Kaunas, Lithuania, e-mail: ktk@if.ktu.lt*

A. Šiurkus

*Department of Telecommunications, Kaunas University of Technology,
Studentų str. 50, LT- 51368 Kaunas, Lithuania, e-mail: arminas.sieurkus@delfi.lt*

Introduction

The emergence of high-speed applications such as videoconferencing, video on demand, TV over Internet and the rapid growth in the number of networked users demand a network architecture which is capable of delivering huge amounts of data in real-time over a wide area.

Optical fiber solution has emerged as an excellent medium for such future networks in view of its huge bandwidth potential (about 50 THz). Apart from its huge bandwidth capability, optical fiber also offers a low attenuation loss (roughly 0.2 dB/km between 1200 nm and 1600nm wavelengths) and low bit-error rates, making it ideally suitable for long-haul communications.

Wavelength division multiplexing (WDM) is a promising technique to utilize the tremendous bandwidth of the optical fiber. Multiple channels can be operated along a single fiber simultaneously, each on a different wavelength. These channels can be independently modulated to accommodate discrepant data formats, including analog and digital signals, depending on demand. So, WDM carves up the huge bandwidth of a single-mode optical fiber into channels whose bandwidths (1-2,5-10 Gbps) are compatible with peak electronic processing speed. WDM-based optical networks are envisaged for local, metropolitan, and wide geographical areas.

The contemporary DWDM (dense WDM) optical technology allows us to create a speedy network, composed out of optical devices, for transmitting information.

The new DWDM technologies and the current network architectures present an active optical network where optical channels are dynamically routed, switched, reserved, observed and restored in the optical layer. Therefore, it is obligatory to plan certain equipment and methods of transmission protection. The analysis of optical main network availability, based on WDM technologies, will be presented in this article.

The contemporary optical network with the speed of transmission at 2.5-10 Gb/s is formed using the WDM technologies. In such a transmission network the nodes perform the functions of switching and adding or dropping signals. The amount of equipment and the type of processing the signals for transmitting the information depend on the used wavelength division technologies.

The basic characteristics of the main WDM network:

- transparent transmission of the signals unprocessed in the node,
- diversity of types and bit rate while transmitting the tributary signals,
- electrooptical conversion only in the terminal nodes of transmission,
- routing formation using the optical waves (a possible wavelength conversion in every node).

Availability of the elements in DWDM backbone network

The backbone network is composed of optical fibers (Op), signal amplifiers (Os), disperse compensators (Dc) and network nodes. Availability of the optical fibers is proportional to its length:

$$A_{op}^d = (A_{op}^1)^d, \quad (1)$$

where A_{op}^1 - availability of 1 km length line.

Let us mark the availability of signal amplifiers A_{So} , and the availability of disperse compensators A_{Dc} . From the point of view of availability a network node can be divided into 3 parts: optical filters, optical connections (transmitters Tx and receivers Rx) and a general part M (Fig. 1). The general part is composed of: a processor (P), a management block (MS), a switchboard (Sw), a power supply block (PS), a fan (Fan).

Availability of the node general part:

$$A_M = A_P * A_{MS} * A_{SW} * A_{PS} * A_F * A_{Fan}; \quad (2)$$

where A_P – availability of a processor (P); A_{MS} – availability of a management block (MS); A_{SW} – availability of a switchboard (Sw); A_{PS} – availability of a power supply block (PS); A_F - availability of a signal filtration and distribution system (F); A_{Fan} – availability of a fan (Fan).

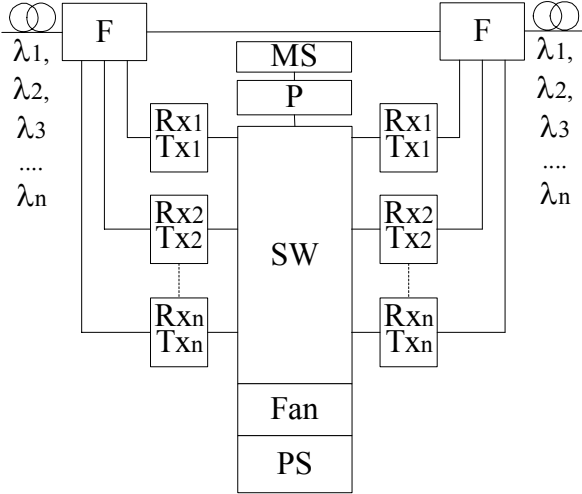

Fig. 1. Structure of an optical network

The structure of each node is identically described in Fig. 1. Amount of physical parts in a node may differ while increasing and decreasing the quantity of transmission directions (change in quantity of the optical connections).

Taking into account the character of a node performed functions, there are 3 possible logical structures of the network node in each transmission way. The first type node M_1 is composed of a general part, two filters and a pair of transmitters/receivers.

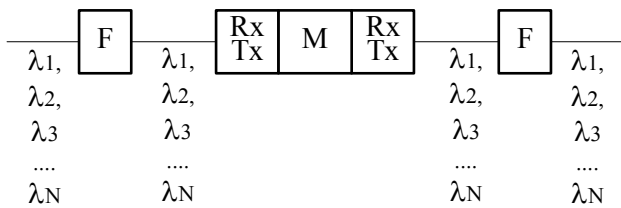

Fig. 2. Structure of M_1 node

Availability of the node M_1

$$A_{M_1}^1 = A_M * (A_F)^2 * (A_W)^2; \quad (3)$$

where A_m - availability of the general part of a node; A_f - availability of a filter; A_w - availability of an optical connection.

The second type node (terminal node) M_2 is composed of a general part, a filter and a transmitter/receiver.

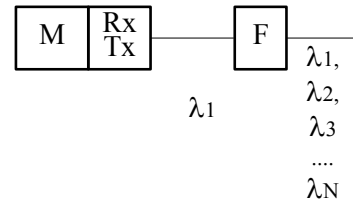

Fig. 3. Structure of M_2 node

Availability of the node M^2

$$A_M^2 = A_M * (A_F) * (A_W). \quad (4)$$

The third type node (transmission node) M_3 is composed of a general part and a pair of filters.

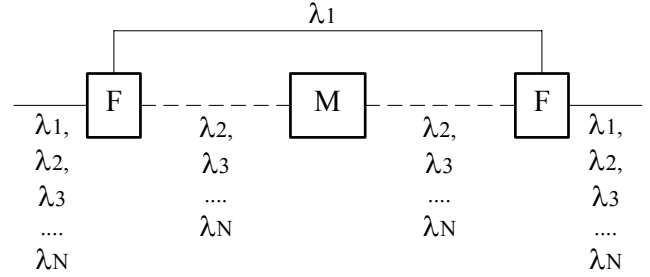

Fig. 4. Structure of M_3 node

Availability of the node M_3

$$A_M^3 = (A_F)^2. \quad (5)$$

The first type node is used as switching and/or transit node, the third type node - only as a transit (in Fig. 4 it is a wavelength λ_1), and the second type node is of a terminal node type.

Availability of a MAN type bus network

The length of a MAN type network is rather small, therefore we will not estimate the availability of a signal intensity and dispersion compensation. The structure of such a network is presented in Fig. 5. It is composed of optical fibers and nodes of a different type network.

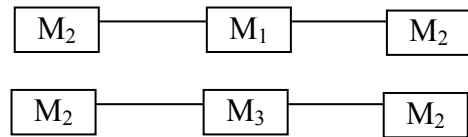

Fig. 5. Availability estimation structure of a network

If the node is of the first type, it is possible to change a wavelength, and the very transmitted signal can be processed. Consequently, the availability of such a network topology is calculated estimating the availability of all the M_3 node, and the availability of all the transmission channel is calculated as the availability of consistently connected elements.

Availability of the first type network M_A

$$A_{M_A}^1 = (A_M^2)^2 * (A_M^1) * (A_{op}^d)^2. \quad (6)$$

If the node is of the first type, a wavelength is not changed and is not switched, but transmitted transitively.

The availability of such a network topology can be calculated only estimating the availability of the signal filtration and distribution system in a transit node.

Availability of the second type network M_B

$$A_{M_B}^1 = (A_M^2)^2 * (A_M^3) * (A_{op}^d)^2 \quad (7)$$

Availability of the bus topology network composed of consistently connected M_1 and M_3 type nodes:

$$A_{M_A}^1(N) = (A_M^2)^2 * (A_M^1)^{N-2} * (A_{op}^d)^{N-1} \quad (8)$$

$$A_{M_B}^1(N) = (A_M^2)^2 * (A_M^3)^{N-2} * (A_{op}^d)^{N-1} \quad (9)$$

Availability of the ring topology network

If the terminal M_2 type nodes are connected directly in the network topology, an M_1 type node is obtained. In this way the topology of a ring network is created. The ring topology is attractive due to its simple control and connections. One-way ring topology is of a full attainment with the least number of connections. The availability of the ring topology will not differ from a network if the ring is one-way.

Let us say, the network of such a ring topology is composed of M_2 and M_1 type nodes. The availability of such a ring topology should be calculated estimating the second (reserved) way on the other side of the ring:

$$\begin{aligned} A_{M_A}^1(N, j) &= \\ &= 1 - \left[1 - (A_M^2)^2 \cdot (A_M^1)^{N-2-j} \cdot (A_{op}^d)^{N-1-j} \right] * \\ &* \left[1 - (A_M^2)^2 \cdot (A_M^1)^j \cdot (A_{op}^d)^{j+1} \right]; \end{aligned} \quad (10)$$

where j – quantity of the nodes used in the main connection between final points.

Availability of the ring topology with the transverse connections

Let us analyze a case when a WDM network is composed of 8 nodes (Fig. 6) where each node has 2 or 3 pairs of transmitters/receivers for transmitting optical signals of a different length-wave. The transmission is analyzed in 2 ways: between 2 adjacent nodes ($M_1 \leftrightarrow M_2$) and between 2 the most remote nodes ($M_1 \leftrightarrow M_5$). Initially we compose a ring of 8 nodes where each node has 2 transmitters and 2 receivers of the fixed wavelength. The i -node transmitter is connected with the $i+1$ node receiver, and the other transmitter is connected with the $i-1$ node receiver.

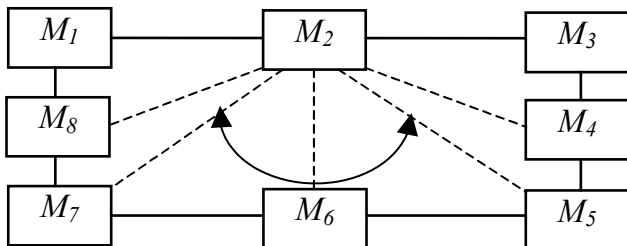

Fig. 6. One-channel ring network topology composed of 8 nodes

Information of the transmission routes from one node to any other is given Table 1.

Table 1. Transmission paths

Point - to - point path	Routes (a – main, b - protection)	
$M_1 \leftrightarrow M_2$	a	$M_1 \leftrightarrow M_2$
	b	$M_1 \leftrightarrow M_8 \leftrightarrow M_7 \leftrightarrow M_6 \leftrightarrow M_5 \leftrightarrow M_4 \leftrightarrow M_3 \leftrightarrow M_2$
$M_1 \leftrightarrow M_3$	a	$M_1 \leftrightarrow M_2 \leftrightarrow M_3$
	b	$M_1 \leftrightarrow M_8 \leftrightarrow M_7 \leftrightarrow M_6 \leftrightarrow M_5 \leftrightarrow M_4 \leftrightarrow M_3$
$M_1 \leftrightarrow M_4$	a	$M_1 \leftrightarrow M_2 \leftrightarrow M_3 \leftrightarrow M_4$
	b	$M_1 \leftrightarrow M_8 \leftrightarrow M_7 \leftrightarrow M_6 \leftrightarrow M_5 \leftrightarrow M_4$
$M_1 \leftrightarrow M_5$	a	$M_1 \leftrightarrow M_2 \leftrightarrow M_3 \leftrightarrow M_4 \leftrightarrow M_5$
	b	$M_1 \leftrightarrow M_8 \leftrightarrow M_7 \leftrightarrow M_6 \leftrightarrow M_5$
$M_1 \leftrightarrow M_6$	b	$M_1 \leftrightarrow M_2 \leftrightarrow M_3 \leftrightarrow M_4 \leftrightarrow M_5 \leftrightarrow M_6$
	a	$M_1 \leftrightarrow M_8 \leftrightarrow M_7 \leftrightarrow M_6$
$M_1 \leftrightarrow M_7$	b	$M_1 \leftrightarrow M_2 \leftrightarrow M_3 \leftrightarrow M_4 \leftrightarrow M_5 \leftrightarrow M_6 \leftrightarrow M_7$
	a	$M_1 \leftrightarrow M_8 \leftrightarrow M_7$
$M_1 \leftrightarrow M_8$	b	$M_1 \leftrightarrow M_2 \leftrightarrow M_3 \leftrightarrow M_4 \leftrightarrow M_5 \leftrightarrow M_6 \leftrightarrow M_7 \leftrightarrow M_8$
	a	$M_1 \leftrightarrow M_8$

The availability A_{Tl} of information transition from one node to any other can be expressed in such a way:

$$\begin{aligned} A_T &= \prod_{i=0}^{N-2} \left[1 - \left[1 - (A_M^2)^2 * (A_M^1)^i \cdot (A_{op}^d)^{i+1} \right] * \right. \\ &* \left. \left[1 - (A_M^2)^2 * (A_M^1)^{N-i} \cdot (A_{op}^d)^{N-i+1} \right] \right] \end{aligned} \quad (11)$$

The analogical expression is possible if we use the node M^3 instead of the node M^1 .

Introducing a transverse connection in a ring (eg. between nodes $M_2 \leftrightarrow M_6$) we receive 2 protection paths from node M_1 to M_2 node. Information of this transmission is given Table 2.

Table 2. Transmission $M_1 \leftrightarrow M_2$ paths

Point - to - point path	Routes (a – main, b - protection)	
$M_1 \leftrightarrow M_2$	a	$M_1 \leftrightarrow M_2$
	b	$M_1 \leftrightarrow M_8 \leftrightarrow M_7 \leftrightarrow M_6 \leftrightarrow M_5 \leftrightarrow M_4 \leftrightarrow M_3 \leftrightarrow M_2$
	c	$M_1 \leftrightarrow M_8 \leftrightarrow M_7 \leftrightarrow M_6 \leftrightarrow M_2$

Node M_6 is the same for both protection paths (where M_6 and M_1 nodes are 3-wayed). Therefore we have the way when the same node is used to compose several channels (eg. a node which node degree - 1 is necessary for a point-to-point connection, while a node degree for the ring topology is 2). In order to assess the availability of the transmission system, it is necessary to consider the fact that a node is composed of elementary/virtual units, the amount of which depends on the mode degree of a node (the amount of transmission directions):

$$A_M = \prod_{i=1}^k A_E ; \quad (12)$$

where k - the amount of the transmission directions using a node; A_E - availability of the node virtual unit.

Then the availability A_T of the architectures for the transmission between the nodes M_1 to M_2 can be expressed as follows:

$$\begin{aligned} A_{M_A}^1 &= 1 - (1 - ((A_M^2)^2 \cdot (A_{op}^d)^1))^* \\ &* (1 - (A_M^2)^2 \cdot (A_M^1)^3 \cdot (A_{op}^d)^5 \cdot (A_M^1)^{\frac{3}{2}} \cdot A_{op}^d)^* \\ &* (1 - (A_M^2)^2 \cdot (A_{op}^d)^2 \cdot (A_M^1)^{\frac{3}{2}} \cdot A_{op}^d) . \end{aligned} \quad (13)$$

With the analogy to 13 expression, $A_{M_A}^1$ is expressed when a transverse connection appears between the nodes $M_1 \leftrightarrow M_3$, $M_1 \leftrightarrow M_4$ and etc. And with the analogy to $A_{M_A}^1$ the availability of $A_{M_A}^2$ is estimated in the same way.

In Fig. 6 there is a diagram to illustrate how the availability of transmission depends on the length of the protection path, when the active components of a network have the significance of availability - 0.9, and the passive components - 0.99 while transmitting from the nodes M_1 to M_2 .

Transmission of information to the remote node in the shortest way using the protection path

Information of two-way transmission channels that are available in the network from the nodes M_1 to M_5 is given in Table 3.

Table 3. Transmission $M_1 \leftrightarrow M_2$ paths

Point - to - point path	Routes (a – main, b - protection)	
	$M_1 \leftrightarrow M_2$	a
	b	$M_1 \leftrightarrow M_2 \leftrightarrow M_3 \leftrightarrow M_4 \leftrightarrow M_5$
	c	$M_1 \leftrightarrow M_8 \leftrightarrow M_7 \leftrightarrow M_6 \leftrightarrow M_5$

$$\begin{aligned} A_{M_A}^1 &= 1 - (1 - (A_M^2)^2 \cdot (A_M^1)^3 \cdot (A_{op}^d)^4)^* \\ &* (1 - (A_M^2)^2 \cdot (A_M^1)^3 \cdot (A_{op}^d)^4) . \end{aligned} \quad (14)$$

We introduce the transverse connections in the analyzed ring alongside with the transmission to the next node. Therefore, 2-way transmission channels are available in the network from the nodes M_1 to M_5 , having a case of the transverse connection between the nodes $M_2 \leftrightarrow M_6$, with the possible transmission channels $M_1 \leftrightarrow M_5$ ($M_1 \leftrightarrow M_2 \leftrightarrow M_3 \leftrightarrow M_4 \leftrightarrow M_5$ or $M_1 \leftrightarrow M_8 \leftrightarrow M_7 \leftrightarrow M_6 \leftrightarrow M_5$ or $M_1 \leftrightarrow M_2 \leftrightarrow M_6 \leftrightarrow M_5$). As it is seen, the transmission nodes

can be repeated in the transmission ways (in the first and the third: M_2 , in the second and the third: M_6).

$$\begin{aligned} A_{M_A}^1 &= 1 - (1 - (A_M^2)^2 \cdot (A_M^1)^1 \cdot (A_{op}^d)^4 \cdot (A_M^1)^{\frac{1}{2}})^* \\ &* (1 - (1 - (A_M^2)^2 \cdot (A_M^1)^1 \cdot (A_{op}^d)^4 \cdot (A_M^1)^{\frac{1}{2}})^* \\ &* (1 - (A_M^2)^2 \cdot (A_{op}^d)^3 \cdot (A_M^1)^{\frac{2}{2}}) . \end{aligned} \quad (15)$$

Values of availability considering to amount of intermediate nodes and the protection paths are given Table 4.

Table 4. Availability of the protection paths

Prot. path	Amount of intermediate nodes (T)/ Transmission path (1↔N)													
	T	1-2	T	1-3	T	1-4	T	1-5	T	1-6	T	1-7	T	1-8
1-2	0	0,990	1	0,989	2	0,989	3	0,989	4	0,988	5	0,988	6	0,988
1-3	1	0,990	0	0,990	1	0,989	2	0,989	3	0,989	4	0,988	5	0,988
1-4	2	0,989	1	0,989	0	0,990	1	0,989	2	0,989	3	0,989	4	0,988
1-5	3	0,989	2	0,989	1	0,989	0	0,990	1	0,989	2	0,989	3	0,989
1-6	4	0,988	3	0,989	2	0,989	1	0,989	0	0,990	1	0,989	2	0,989
1-7	5	0,988	4	0,988	3	0,989	2	0,989	1	0,989	0	0,990	1	0,990
1-8	6	0,988	5	0,988	4	0,988	3	0,989	2	0,989	1	0,989	0	0,990

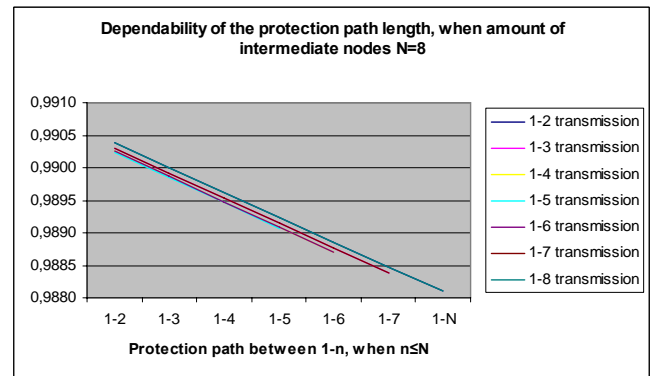

Fig. 7. Dependability of the protection path length

Information transmission into several used reserved ways

Let us introduce several or even more transverse connections into the analyzed ring. The amount of transverse connections varies from 0 to n during the transmission between two any nodes. While summing up, we can present the availability of the ring topology during the transmission between the two nodes:

$$A_{M_A}^1 = 1 - \left(\frac{1 - (A_M^2)^2 \cdot (A_{op}^d)^{KA-Nk+\frac{Nk}{k}+1}}{(A_M^1)^{KA-Nk+\frac{Nk}{k}}} \right) * \left(\frac{1 - (A_M^2)^2 \cdot (A_{op}^d)^{KB-Nk+\frac{Nk}{k}+1}}{(A_M^1)^{KB-Nk+\frac{Nk}{k}}} \right) * \prod_{i=1}^R \left(\frac{1 - (A_M^2)^2 \cdot (A_{op}^d)^{KR-Nk+\frac{Nk}{k}+1}}{(A_M^1)^{KR-Nk+\frac{Nk}{k}}} \right); \quad (15)$$

where KA , KB - the amount of transmission paths while transmitting the signal on one or the other side of the ring; KR - the amount of protection paths while transmitting the signal on the protection path; R - the amount of the protection paths; k - the node degree; Nk - the amount of the nodes with the k node degree.

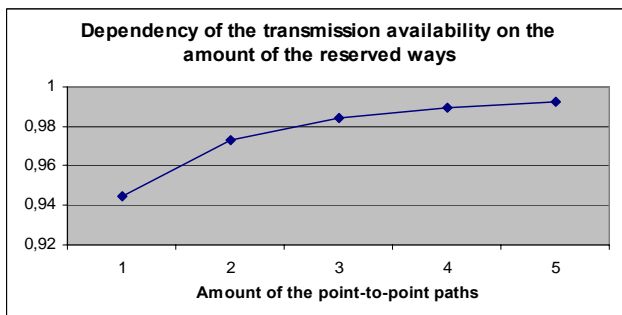

Fig. 8. Dependency of the transmission availability on the amount of the reserved ways

Conclusions

R. Plėštys, A. Šiurkus. Information Transmission Availability in WDM Networks // Electronics and Electrical Engineering. – Kaunas: Technologija, 2006. – No. 6(70). – P. 55–59.

This paper deals with the system availability estimation schemes in WDM (Wavelength Division Multiplexing) optical networks and it provides for each network topology analysis of the availability. The methodology to calculate the reliability of the optical network logical connections is introduced here. Possibilities of interferences in the connection have been calculated while assessing the amount of the reserved ways and the amount of elements in the network in every logical channel. We consider single or multiple link protection scenarios. Availability models and formulas are followed by some numerical examples that allow us to estimate availability and compare data for the different network topologies. Ill. 8, bibl. 5. (in English; summaries in English, Russian and Lithuanian).

Р. Плештис, А. Шюркус. Определение надежности WDM сетей // Электроника и электротехника. – Каунас: Технология, 2006. – № 6(70). – С. 55–59.

Представлены схемы, оценивающие наличие WDM. Анализируется наличие каждой топологии в сети. В данной работе представлен анализ наличия оптических MAN сетей, основанных на WDM технологиях. Этот анализ представлен по предложенной структуре оптической сети, составленной из идентичных элементов. Представлена методика расчета наличия логических связей в оптической сети, оценивающая возможность передачи информации между двумя ближайшими и двумя дальними узлами в сети. Полученные результаты расчета вероятных поломок в сети, оценивающие число резервированных логических каналов и число сетевых элементов в каждом логическом канале. Илл. 8, библи. 5. (на английском языке; рефераты на английском, русском и литовском яз.).

R. Plėštys, A. Šiurkus. Informacijos perdavimo rezervavimas WDM tinkle // Elektronika ir elektrotechnika.- Kaunas: Technologija, 2006. – Nr. 6(70). – P. 55–59.

Pateiktos WDM (Wavelength Division Multiplexing) tinklo pateikiamumo įvertinimo schemas. Analizuojamas kiekvienos tinklo topologijos pateikiamumas. Darbe pateikta optinių WDM technologijomis paremta MAN tinklų pateikiamumo analizė pagal pasiūlytą optinio tinklo, sudaryto iš identiškų elementų, struktūrą. Pateikta optinio tinklo loginių ryšių patikimumo skaičiavimo metodika, įvertinanti galimus informacijos perdavimus tarp dviejų gretimų mazgų ir tarp dviejų tolimiausių mazgų tinkle. Gauti ryšio sutrikimo

This paper presents the analysis of the main optical network availability based on WDM technologies according to the proposed structure of the optical network composed of identical elements. The methodology to calculate the reliability of the optical network logical connections is introduced here. It enables to assess the possible ways of information transformation between two adjacent and two remote nodes in the network. Possibilities of interferences in the connection have been calculated while assessing the amount of the reserved ways and the amount of elements in the network in every logical channel. Due to the presented diagrams of availability it is seen that the amount of nodes in the network is 8 and the optimum amount of the reserved ways is 2-3.

References

1. **Balaišis P., Plėštys R., Šiurkus A.** Estimation of the photonic backbone network reliability // Proceedings of 5th international conference Electronics-2001. – Kaunas: Technologija, 2001. – P. 11–14.
2. **Plėštys R., Šiurkus A.** Estimation of the photonic homogenous network reliability // Electronics and Electrical Engineering. – Kaunas: Technologija, 2003. – No. 6(48). – P. 71–74.
3. **R. Plėštys, A. Šiurkus.** On Improvement of WDM Network Reliability // Electronics and Electrical Engineering. – Kaunas: Technologija, 2005. – No. 6(62). – P. 88–92.
4. **Balaišis P., Eidukas D., Valinevičius A., Žilys M.** Informacinių elektroninių sistemų efektyvumas. – Kaunas: Technologija, 2004. – 360 p.
5. **Crowe D., Feinberg A.** Design for reliability. – CRC Press LLC, 2001. – 256 p.

Submitted 2006 03 01

tikimybių skaičiavimo rezultatai, įvertinantys rezervuojančių loginių kanalų skaičių ir tinklo elementų skaičių kiekviename loginiame kanale. Il. 8, bibl. 5 (anglų kalba; santraukos anglų, rusų ir lietuvių k.).