

Structural and functional characteristics of the lifting mechanism in universal rocket transportation launching device

A. Fedaravičius*, K. Pilkauskas**, E. Sližys***, A. Survila****

*Kaunas University of Technology, Institute of Defence Technologies Kęstučio str. 27, LT-44312 Kaunas, Lithuania, E-mail: algimantas.fedaravicius@ktu.lt

**Kaunas University of Technology, Studentų str. 56-346, LT-51424 Kaunas, Lithuania, E-mail: kesttis.pilkauskas@ktu.lt

***Kaunas University of Technology, Institute of Defence Technologies Kęstučio str. 27, LT-44312 Kaunas, Lithuania, E-mail: egidijus.slizys@ktu.lt

****Kaunas University of Technology, Institute of Defence Technologies Kęstučio str. 27, LT-44312 Kaunas, Lithuania, E-mail: arvydas.survila@ktu.lt

 <http://dx.doi.org/10.5755/j01.mech.21.3.12261>

1. Introduction

The issue of research and development of a universal rocket transportation launching device which serves as an important structural part of the air target system under development is addressed in the paper. This air target system intended to be used for practical field training of the crew members of anti-aircraft missile system is comprised of the rocket type air target and its transportation launching system. When launched from the latter system the air target should reconstruct flight parameters of an aircraft or other aerial vehicle thus simulating combat situations for anti-aircraft missile system crew. In turn the device under development integrates two functions – transportation of the rocket type target to the launch field and its quick transition (positioning) to the launch position.

Due to economic reasons the principle concept used for the developed universal rocket transportation launching device is single axle trailer with the integrated rocket guides lifting-positioning mechanism while all the system being towed by commercial cargo vehicle. From functional viewpoint this concept is close to the one used in dumping trailers the payload bed of which is tilted by a lifting mechanism thus creating conditions for dumping action [1-3]. In the majority of towable dumping trailers, hydraulic power is utilized to initiate dumping mechanisms, nevertheless research on structural parameters in order to achieve the desired dynamical characteristics of the output link is not provided in the mentioned reference sources. Here the main focus is made on operational principles and strength characteristics of relatively moving rigid frames.

Also the trailers' structures, the frames of which are tilted one with respect to another by cable mechanisms are known [4, 5]. In these reference sources the main focus is made on achieving effectively the tilted position of the bed not considering dynamics of the tilting motion. The principle of generating tilting motion of the dump bed by forward and backward motion of the towing vehicle is presented in [6, 7]. Here the stress is made on achieving easy (and effective) operation of the system without leaving the cabin of towing vehicle by its operator.

Summarizing it can be stated that motion characteristics of the tilting bed are out of concern in the mentioned developments.

P. Somoig and C-E. Moldoveanu [8] performed

numerical research of the oscillations of the rocket launched from tilting platform mounted on a revolved support installed in a vehicle with the aim to determine their effects on initial conditions of the rocket path. Here the oscillating rocket was considered as an element of the system consisting of the vehicle's elastic suspension, revolving and tilting mechanisms having elastic properties. Nevertheless kinematical and dynamical characteristics of the rocket guide tube tilting mechanism on the initial characteristics were not researched.

Conceptually the universal rocket transportation launching device was developed as hydraulically actuated linkage installed on a single axle trailer intended to be towed by a cargo vehicle. Due to the requirements for high mobility of the system and in particular cases at off-road conditions, the system should meet reliable stability requirements at relatively high motion speeds together with severe inputs due to tire road interaction. This sets constraints on mass distribution of the system and in turn on vertical dimensions of the rocket lifting mechanism – its vertical dimensions in transportation mode should be minimized.

In order to ensure short duration transition from transportation to the launching mode, the proper positioning and motion characteristics (to have the necessary launching conditions) of the rocket guides, kinematical and dynamical analysis of the rocket lifting mechanism was performed.

2. Theoretical model of the rocket lifting mechanism

Rocket lifting mechanism was developed as a six bar linkage actuated by hydraulic cylinder. Its structural diagram is presented in Fig. 1. From the structural viewpoint this mechanism was developed starting with a four bar linkage with a sliding block (kinematic chain OO_1AB) and supplementing it with a two arm group CDE (Fig. 1). The guides used for rocket positioning are associated with the link DE of the length l_4 . According the used vector analysis method [9, 10], two vector polygons according the mechanism structure were constructed. On the basis of these polygons, dependences of structural and kinematical parameters of the rocket guiding (positioning) link on actuating inputs of hydraulic cylinder were derived. Two phases were used for performing the mechanism analysis – at the first one kinematical parameters of the links included

into the kinematic chain OO_1AB were derived and using the obtained parameters in the second phase motion parameters of the rocket positioning link which is included into the structure of the chain O_1CDE were obtained.

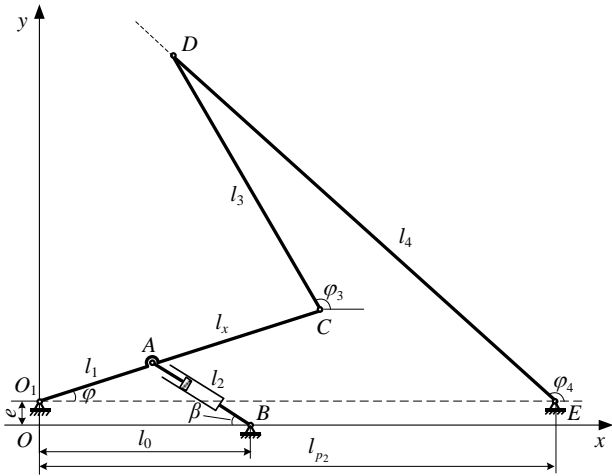

Fig. 1 Kinematic diagram of the rocket lifting mechanism

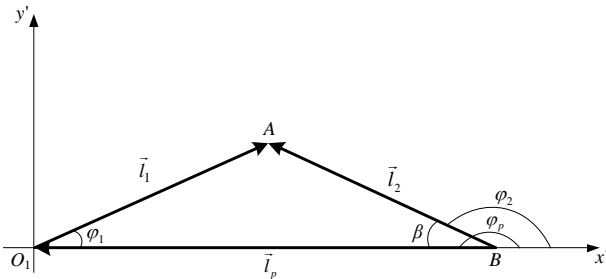

Fig. 2 Vector polygon of the four bar linkage with a sliding block constructed on the basis of kinematic chain OO_1AB

Vector polygon constructed on the basis of first kinematic chain is presented in Fig. 2. Its closure equation is:

$$\vec{l}_p + \vec{l}_1 = \vec{l}_2. \tag{1}$$

With the use of complex polar algebra approach, vector Eq. (1) can be rearranged as follows:

$$l_p e^{j\varphi_p} + l_1 e^{j\varphi_1} = l_2 e^{j\varphi_2}, \tag{2}$$

By applying Euler's identity ($e^{\pm j\vartheta} = \cos \vartheta \pm j \sin \vartheta$) and then separating real and imaginary parts, Eq. (2) gives:

$$\left. \begin{aligned} l_2 &= \sqrt{l_p^2 + l_1^2 - 2l_p l_1 \cos \varphi_1}; \\ \varphi_2 &= \arctg \left(\frac{l_1 \sin \varphi_1}{l_1 \cos \varphi_1 - l_p} \right). \end{aligned} \right\} \tag{3}$$

The system of Eq. (3) relates the input actuating parameter - length of hydraulic cylinder l_2 and positioning angles of other mechanism links.

For performing velocity analysis of the mechanism links, Eq. (2) is differentiated with respect to time

what resulted in:

$$j\dot{\varphi}_1 l_1 e^{j\varphi_1} = \dot{l}_2 e^{j\varphi_2} + j\dot{\varphi}_2 l_2 e^{j\varphi_2}. \tag{4}$$

By applying Euler's identity, then separating real and imaginary parts, the following kinematical relationships were derived:

$$\left. \begin{aligned} \dot{l}_2 &= \omega_1 l_1 \sin(\varphi_2 - \varphi_1) \Leftrightarrow \omega_1 = \frac{\dot{l}_2}{l_1 \sin(\varphi_2 - \varphi_1)}; \\ \omega_2 &= \omega_1 \frac{l_1}{l_2} \cos(\varphi_2 - \varphi_1). \end{aligned} \right\} \tag{5}$$

Eq. (5) relate actuating parameter - velocity of the hydraulic cylinder (input) with the angular velocities of other mechanism links.

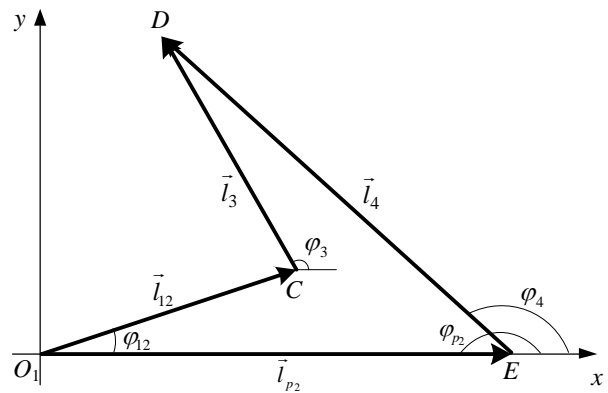

Fig. 3 Vector polygon representing kinematic chain O_1CDE of the mechanism

Vector polygon representing kinematic chain O_1CDE was used in order to derive angular kinematic parameters of the rocket guides (Fig. 3). Its loop closure equation is as follows:

$$\vec{l}_{p2} + \vec{l}_{12} + \vec{l}_3 = \vec{l}_4. \tag{6}$$

Expressed in complex polar form it yields:

$$l_{p2} e^{j\varphi_{p2}} + l_{12} e^{j\varphi_{12}} + l_3 e^{j\varphi_3} - l_4 e^{j\varphi_4} = 0. \tag{7}$$

After differentiation of Eq. (7) with respect to time using Euler's identity and separating real and imaginary parts angular velocities of the links are expressed as follows:

$$\left. \begin{aligned} \omega_3 &= \frac{l_{12} \sin(\varphi_{12} - \varphi_4)}{l_3 \sin(\varphi_4 - \varphi_3)} \omega_{12}; \\ \omega_4 &= \frac{l_{12} \sin(\varphi_{12} - \varphi_3)}{l_4 \sin(\varphi_4 - \varphi_3)} \omega_{12}. \end{aligned} \right\} \tag{8}$$

For motion parameters analysis of the mechanism links Eq. (8) are convenient to be used due to the fact that link l_2 (the angular velocity of which is ω_{12}) is directly actuated by hydraulic cylinder and therefore can be considered as input.

In Fig. 4 position angle φ_1 as function of length l_2 which represents stroke of hydraulic cylinder is presented and in Fig. 5 angular velocity ω_1 as function of length l_2 are presented.

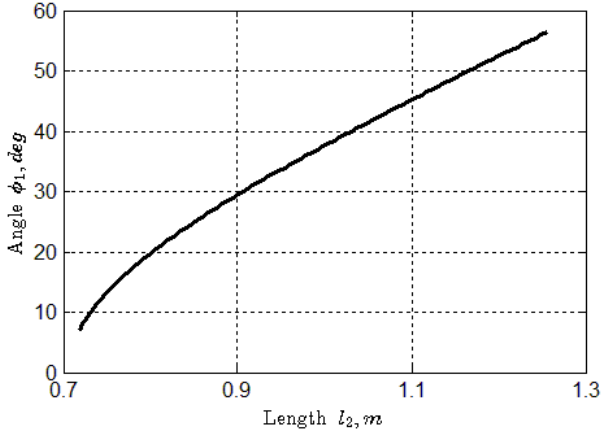

Fig. 4 Position angle of the link l_1 as function of length of the actuating link l_2 – hydraulic cylinder

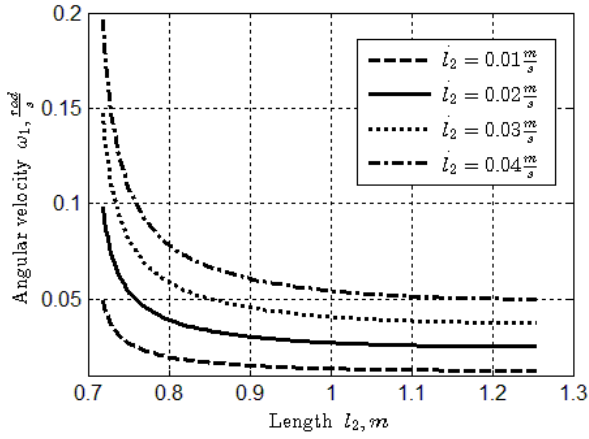

Fig. 5 Angular velocity of the link l_1 (b) as function of length of the actuating link l_2 – hydraulic cylinder

Angular velocities ω_3 and ω_4 obtained with the use of Eq. (8) are presented in Fig. 6 and Fig. 7.

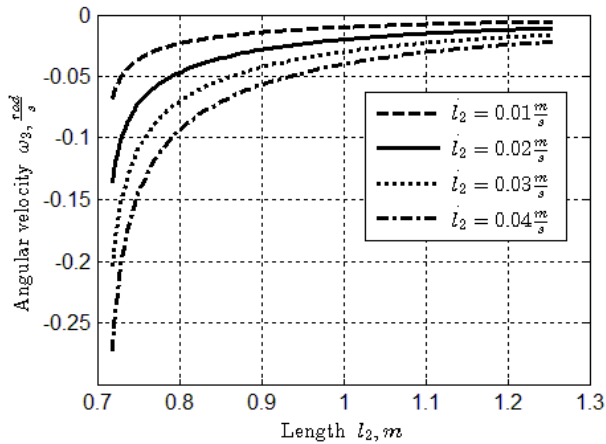

Fig. 6 Angular velocity of the mechanism link l_3 as function of the length of the actuating link l_2 – hydraulic cylinder at different actuating velocities

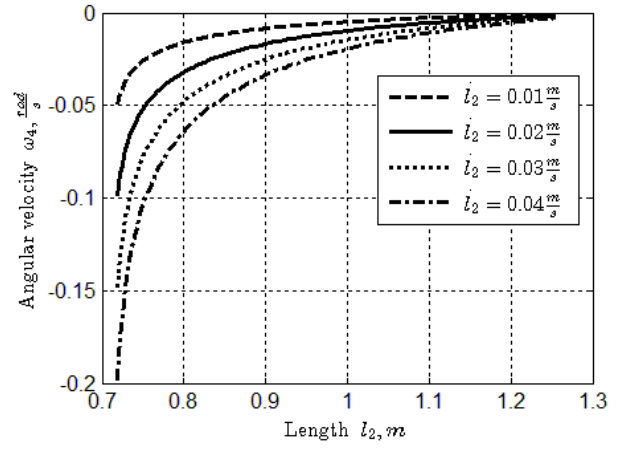

Fig. 7 Angular velocities of the mechanism link l_4 as function of the length of the actuating link l_2 – hydraulic cylinder at different actuating velocities

From loop closure Eq. (7) which represents kinematic chain O_1CDE the separation of real and imaginary parts yields in the following set of equations:

$$\begin{cases} l_p \cos \varphi_p + l_4 \cos \varphi_4 + l_3 \cos \varphi_3 - l_{12} \cos \varphi_{12} = 0; \\ l_p \sin \varphi_p + l_4 \sin \varphi_4 + l_3 \sin \varphi_3 - l_{12} \sin \varphi_{12} = 0. \end{cases} \quad (9)$$

In order to ensure velocity stability of the rocket guides, acceleration analysis of the links in kinematic chain O_1CDE was performed with the aim to derive functional relationships between kinematic parameters of links l_3 and l_{12} and position angle φ_4 in case angular velocity ω_4 is set.

Differentiating Eq. (9) with respect to time twice and making rearrangements results in the following:

$$\begin{cases} \omega_3 = \varphi_3' \omega_4; \\ \omega_{12} = \varphi_{12}' \omega_4; \\ \varepsilon_3 = \varphi_3'' \omega_4^2 + \varphi_3' \varepsilon_4; \\ \varepsilon_{12} = \varphi_{12}'' \omega_4^2 + \varphi_{12}' \varepsilon_4; \end{cases} \quad (10)$$

where first order kinematical coefficients are:

$$\begin{cases} \varphi_3' = \frac{d\varphi_3}{d\varphi_4} = \frac{-l_4 \sin(\varphi_4 - \varphi_{12})}{l_3 \sin(\varphi_3 - \varphi_{12})}; \\ \varphi_{12}' = \frac{d\varphi_{12}}{d\varphi_4} = \frac{-l_4 \sin(\varphi_4 - \varphi_3)}{l_{12} \sin(\varphi_3 - \varphi_{12})}. \end{cases} \quad (11)$$

And second order kinematical coefficients are:

$$\begin{cases} \varphi_3'' = \frac{d^2\varphi_3}{d\varphi_4^2} = \frac{-M \cos \varphi_{12} - N \sin \varphi_{12}}{l_3 \sin(\varphi_3 - \varphi_{12})}; \\ \varphi_{12}'' = \frac{d^2\varphi_{12}}{d\varphi_4^2} = \frac{-M \cos \varphi_3 - N \sin \varphi_3}{l_{12} \sin(\varphi_3 - \varphi_{12})}; \end{cases} \quad (13)$$

where

$$\left. \begin{aligned} M &= l_4 \cos \varphi_4 + l_3 \cos \varphi_3 \cdot \varphi_3'^2 - l_{12} \cos \varphi_{12} \cdot \varphi_{12}'^2; \\ N &= l_4 \sin \varphi_4 + l_3 \sin \varphi_3 \cdot \varphi_3'^2 - l_{12} \sin \varphi_{12} \cdot \varphi_{12}'^2. \end{aligned} \right\} \quad (14)$$

With the application of Eq (10-14), angular velocities and accelerations of links l_3 and l_{12} as functions of position angle φ_4 at different angular velocities of the rocket guides were obtained. Results of the simulation are presented in Figs.8-11.

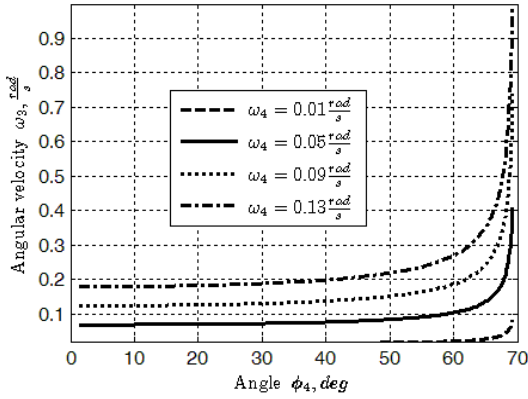

Fig. 8 Functional dependency of angular velocities of link l_3 on position angle φ_4 at different angular velocities of l_4

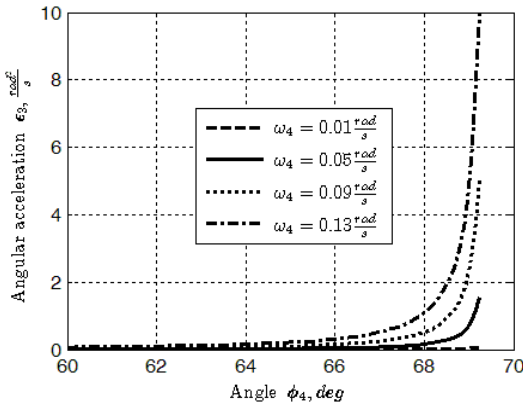

Fig. 9 Functional dependency of angular accelerations of link l_3 on position angle φ_4 at different angular velocities of l_4

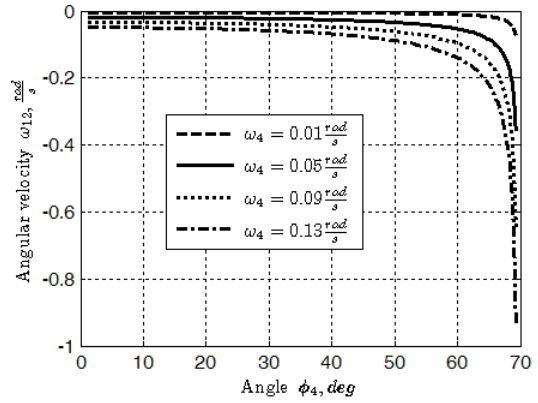

Fig. 11 Functional dependency of angular velocities of link l_{12} on position angle φ_4 at different angular velocities of l_4

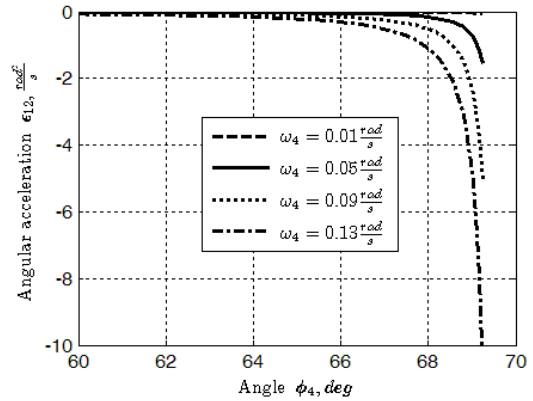

Fig. 11 Functional dependency of angular accelerations of link l_{12} on position angle φ_4 at different angular velocities of l_4

Summarizing it can be stated that functional relationships between actuating inputs – stroke of hydraulic cylinder represented by length l_2 , its piston velocity represented by \dot{l}_2 and angular velocities $\omega_1, \omega_2, \omega_3, \omega_4$ were obtained. Functional relationships of angular accelerations of the links l_3 and l_{12} and position angle φ_4 at different angular velocities of the rocket guides were obtained.

The universal rocket transportation – launching device with the rocket lifting mechanism in the launching mode is presented in Fig. 12.



Fig. 12 Universal rocket transportation – launching device

4. Conclusions

1. Functional relationships relating input actuating parameters – stroke of hydraulic cylinder and velocity of its piston with motion parameters of other links and necessary for the analysis of performance characteristics of rocket lifting mechanism were derived.

2. The obtained relationships form the basis for the development of control system of the actuator.

3. Kinematic parameter analysis of the rocket lifting mechanism indicates that the mechanism ensures effective transition of the rocket from transportation to the launching mode.

4. With the use of acceleration analysis results, internal loads in kinematic pairs can be determined what forms the background for strength and rigidity analysis of the mechanism.

References

1. Dumping Trailer. US patent 5069507, 1991
2. Dump Vehicle. US patent, 1975
3. Dump Trailer. US patent, 1948
4. Cable Actuated Dump Trailer Assembly. US patent 8662598B1, 2014
5. Scissor Tail Dump Trailer apparatus. US patent. 4418959, 1983
6. Dump Trailer. US patent 8876216B2, 2014
7. Dump Trailer. US patent 8245717B2, 2014
8. **Samoia, P.; Moldoveanu, C-E.** 2013. Numerical research on the stability of launching devices during firing, Defence Technology 9, China Ordnance Society, Production and Hosting by Elsevier, 242-248.
9. **Uicker, J.J.; Pennock, G.R.; Shigley, J.E.** 2003. Theory of Machines and Mechanisms, Oxford University Press, 734 p.
10. **Mabie, H.; Reinholtz, Ch.F.** 1987. Mechanisms and Dynamics of Machinery, John Wiley&Sons, 644 p.

A. Fedaravičius, K. Pilkauskas, E. Sližys, A. Survila

STRUCTURAL AND FUNCTIONAL CHARACTERISTICS OF THE LIFTING MECHANISM IN UNIVERSAL ROCKET TRANSPORTATION LAUNCHING DEVICE

S u m m a r y

The focus on the research of structural parameters and determination of functional characteristics of the rocket lifting mechanism – the important subsystem of universal rocket transportation launching device is made in the paper. The latter device is intended for the transportation of rocket-type targets and their effective launching during field training process of anti-aircraft missile system crews. The device is developed by integrating transportation subsystem in the form of single axle (light weight) trailer and launching subsystem – a six bar hydraulically actuated linkage. The launching device able to ensure necessary launching angles (in the range 30°-70°), fast transition from the transportation to the launching mode and together meeting constraints set by motion stability requirements at transportation mode was developed. By performing structural analysis a set of links' geometrical parameters enabling the launching angle range and having minimized vertical dimensions at transportation mode were selected. By kinematical analysis of the linkage, input parameters of actuating hydraulic cylinder ensuring constant velocity and smooth motion of the rocket guides were determined. The performed field tests of air target launching proved efficient operation of the developed rocket transportation launching device.

Keywords: Rocket lifting mechanism, rocket launching mode, kinematic parameters, six bar linkage.

Received May 14, 2015

Accepted August 24, 2015