

Darius Albrektas¹, Agnė Styraitė²

Modelling and Investigating Real-World Drying Defects in Wood

Modeliranje i istraživanje stvarnih grešaka sušenja drva

ORIGINAL SCIENTIFIC PAPER

Izvorni znanstveni rad

Received – prispjelo: 20. 10. 2020.

Accepted – prihvaćeno: 23. 3. 2022.

UDK: 630*81; 674.047.3

<https://doi.org/10.5552/drvind.2022.2040>

© 2022 by the author(s).

Licensee Faculty of Forestry and Wood Technology, University of Zagreb.

This article is an open access article distributed under the terms and conditions of the Creative Commons Attribution (CC BY) license.

ABSTRACT • Depending upon the conditions in which they are used, wood products are required to have been produced with the necessary moisture levels for the intended job. In many cases, this means that drying is required in order to achieve these moisture levels. Wood is also often thermally modified. During the required processing, stresses often occur in wood assortments. If such stresses exceed the limits of durability in the wood, cracks will appear. Similar cracks in wood can occur prior to the drying and/or heat treatment stage. These defects are usually internal and invisible, but they can significantly alter the mechanical properties of the product. This study has shown that wood defects can often be detected using the original method, which involved transverse resonant vibrations, invisible drying, and others. It has been found that a defect of at least 12.5 % of the specimen's overall length will change the mechanical properties of that specimen. When the defect length makes 25 % of the specimen's overall length, or even more, the assortment sometimes behaves as a system of several bodies. In addition, when the defect reaches half the total length of the specimen, the modulus of elasticity may decrease to 20 %, and the coefficient of damping may increase to 80 %.

KEYWORDS: wood moisture content; drying defects; resonant frequency; amplitude characteristics; transverse vibrations; modulus of elasticity; coefficient of damping

SAŽETAK • Proizvodi od drva u konačnici moraju imati određen sadržaj vode, ovisno o mjestu njihove uporabe. To najčešće znači da je drvo potrebno osušiti kako bi se postigao željeni sadržaj vode u njemu. Drvo je često i toplinski modificirano. Tijekom sušenja u drvnim se sortimentima često pojavljuju naprezanja. Ako ona prelaze razinu graničnih naprezanja drva, nastat će pukotine. Slične pukotine u drvu mogu se pojaviti prije faze sušenja i/ili toplinske obrade. Te se greške obično nalaze unutar drvnog elementa i nevidljive su, ali znatno utječu na mehanička svojstva proizvoda. Ovo je istraživanje pokazalo da se greške drva često mogu otkriti originalnom metodom koja podrazumijeva poprečne rezonantne vibracije, nevidljivo sušenje i druge postupke. Utvrđeno je da će greška drva duga najmanje 12,5 % ukupne duljine uzorka promijeniti mehanička svojstva tog uzorka. Kada duljina greške iznosi 25 % ili više ukupne duljine uzorka, drveni se element u nekim primjerima ponaša kao sustav nekoliko tijela. Osim toga, ako greška drva dosegne polovicu ukupne duljine uzorka, modul elastičnosti može se smanjiti do 20 %, a koeficijent prigušenja porasti do 80 %.

KLJUČNE RIJEČI: sadržaj vode u drvu; greške sušenja; rezonantna frekvencija; amplitudna obilježja; poprečne vibracije; modul elastičnosti; koeficijent prigušenja

¹ Author is associate professor at Kaunas University of Applied Sciences, Faculty of Technology, Kaunas, Lithuania.

² Author is student at Kaunas University of Technology, Faculty of Mechanical Engineering and Design, Kaunas, Lithuania.

1 INTRODUCTION

1. UVOD

Depending upon the intended conditions of use of wood products, such products will need to contain a moisture content of between 6-20 %. The moisture content in uncut, living wood, which is part of a growing tree, tends to vary from about 40 % to 90 % or more, depending upon the tree species, the season of the year, and various other factors ('Wood handbook', 2010; Perré *et al.*, 2004). If wood is selected with the wrong moisture content for the job at hand, then later, during its use, the moisture levels will reach a value that corresponds to the environmental conditions. However, during the drying or wetting process, products or parts of those products may change dimensions and shape, possibly losing their aesthetic appearance and functionality, while visible or even invisible cracks or other defects may show up (Dietsch, 2017). In order to be able to avoid such problems, wood, in most cases, must be dried.

In order to reduce drying times and achieve higher economic benefits, wood is subject to a harsher drying regime. It is processed at higher temperatures and in drier air. However, as a result of such a drying process, in most cases a cross-section of dried wood assortments will show considerable levels of humidity difference, which can lead to stress formation (Perré *et al.*, 2004; Karabagli *et al.*, 1997). Exceeding the strength limit of wood causes the appearance of cracks and other defects. These defects are often internal and invisible and, therefore, they can often only be noticed following mechanical treatment. Furthermore, they significantly impair the mechanical properties of wood (Oltean *et al.*, 2007).

Thermal modification of wood changes some of its properties (being heated at an even higher temperature, between 160-260 °C), making it resistant to environmental influences (Oltean *et al.*, 2007; Poncsak *et al.*, 2006). Heat treatment results in changes in the chemical composition of wood, as well as in the removal of extractives, etc. Furthermore, in many cases the wood also dries out, creating stresses due to the varying shrinkages of separate zones and temperature differences. Again, exceeding the strength limit of wood causes the appearance of cracks and other defects, often not visible to the naked eye. Therefore, the wood must be treated to an optimised regime during both the drying and thermal modification stages. Furthermore, internal, invisible defects may occur prior to the drying or heat treatment phases.

The process of assessing mechanical properties, along with defect-finding and modelling, uses various acoustic and other non-destructive methods (Poncsak *et al.*, 2020; Kamal *et al.*, 2017; Perlsaksson, 2018; Hamdi *et al.*, 2016). The values in the mechanical properties of wood, as determined by using dynamic

methods, tend to correlate well with values obtained by using static methods (Wang *et al.*, 2000; Vobolis *et al.*, 2013; Hossein *et al.*, 2011). The relationship between the dynamic and static modulus of elasticity was found to be about 0.91. However, when a defect occurs, this relationship decreases to 0.51 (Hossein *et al.*, 2011).

The aim of this study was to evaluate the possibility of being able to detect wood defects by applying a transverse resonant vibration method so that it becomes possible to determine the influence of such defects on the mechanical properties of the product.

2 MATERIALS AND METHODS

2. MATERIJALI I METODE

The study involved timber specimens of the birch family (*betula pendula*), with varying dimensions as follows: 400 mm × 50 mm × 20 mm (involving twenty items, and categorised as Group 1); 400 mm × 50 mm × 30 mm (twenty items, Group 2); and 400 mm × 50 mm × 40 mm (twenty items, Group 3). The moisture content in the wood following conditioning varied from 10.7 % to 11.5 %, with density levels of between 590-650 kg/m³ (moisture content and density values were determined according to the standards LST EN 13183-2:2003 and LST EN 323:1999).

The specimens were weighed on an electronic scale with an accuracy level of 0.01 g, and were measured using callipers (the length with an accuracy of 0.05 mm, and thickness and width with an accuracy of 0.02 mm). Amplitude frequency characteristics fell within the 20-2000 Hz frequency range, being determined using the original methodology and equipment (Albrektas *et al.*, 2003).

A test stand (Figure 1) was used to determine the modulus of elasticity (*MOE*) and the coefficient of damping based on non-destructive testing (employing

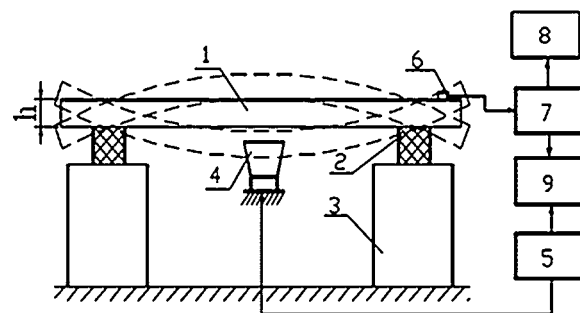

Figure 1 Schematic for test stand: 1 – specimen; 2 – vibration damping material (foam rubber); 3 – solid supports; 4 – loudspeaker; 5 – vibration generator; 6 – sensor; 7 – measuring instrument; 8 – oscilloscope; 9 – phase meter; *h* – thickness of specimen

Slika 1. Shema ispitnog postolja: 1 – uzorak; 2 – materijal za prigušivanje vibracija (pjenasta guma); 3 – čvrsti nosači; 4 – zvučnik; 5 – generator vibracija; 6 – senzor; 7 – mjerni instrument; 8 – osciloskop; 9 – mjerač faza; *h* – debljina uzorka

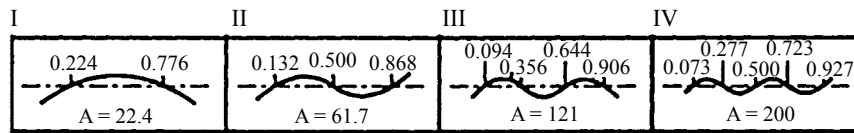

Figure 2 The first four modes of theoretical isotropic beam, when both ends are fixed ‘freely.’ The curve shows the vibration mode of theoretical isotropic beam (I, II, III, IV, respectively), numerical values show relative distances from the end of theoretical isotropic beam to the point where the vibration amplitude is 0 and ‘A’ is a coefficient, depending on fastening method of specimen and on vibration mode.

Slika 2. Prva četiri načina vibracije teorijske izotropne grede kada su oba njezina kraja „slobodno” učvršćena. Krivulja predložuje način vibracije teorijske izotropne grede (I, II, III, IV), brojčane vrijednosti pokazuju relativne udaljenosti od kraja teorijske izotropne grede do točke gdje je amplituda vibracije 0, a A označava koeficijent, ovisno o načinu pričvršćenja uzorka i načinu vibracije.

transverse resonant vibrations), which also made it possible to assess the mechanical properties of the specimens (Albrektas *et al.*, 2003; Vobolis *et al.*, 2013; Timoshenko *et al.*, 1985). The studies were carried out at a frequency of 20-2000 Hz.

A beam-shaped body, which vibrates at a resonance (natural) frequency, depending on its anchorage, curves to a corresponding shape (mode), which, in many cases, is close to the mode of a theoretical isotropic beam. The first four modes of the theoretical isotropic beam - with the beam fixed ‘freely’ at both ends (as on the stand for the tested specimens) - are presented in Figure 2 (Broch, 1984).

The *MOE* was calculated based on the following Eq. 1 (Timoshenko *et al.*, 1985):

$$E = \frac{f_{rez}^2 \cdot 4 \cdot \pi^2 \cdot \rho \cdot s \cdot l^4}{I \cdot A^2} \quad (1)$$

Where: E is modulus of elasticity; f_{rez} is frequency of transverse vibrations; ρ is density of wood; s is cross-sectional area; l is beam length; I is cross-sectional moment of inertia; and A is e fastening method being used, as represented by a coefficient (Figure 2).

The viscous properties (coefficient of damping) of the specimens being studied were evaluated based on the following Eq. 2:

$$\operatorname{tg} \delta \approx \frac{\Delta f}{f_{rez}} \quad (2)$$

Where: f_{rez} is frequency of transverse vibrations; Δf is frequency bandwidth when vibration amplitude decreases by 0.7 times.

After determining the characteristic (first) mode of vibration specimens, the *MOE* and coefficient of damping of wood were both calculated (Timoshenko *et al.*, 1985).

Subsequently, the specimens from all three groups were divided into subgroups: Group 1 into Subgroups 1.1 and 1.2; Group 2 into Subgroups 2.1 and 2.2; and Group 3 into 3.1 and 3.2. There were ten samples in each subgroup.

Drying defects were simulated for specimens in subgroups 1.1, 2.1, and 3.1. An incision was made along the specimen (between every 50 mm to 200 mm, over the entire thickness of that specimen (Figure 3).

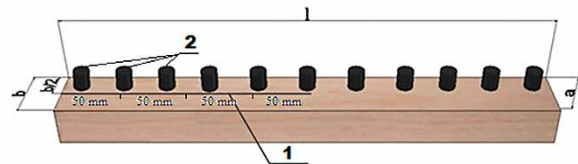

Figure 3 The principle used for forming incisions in the specimen: 1 – incision, gradually increasing every 50 mm to 200 mm; 2 – locations of sensor mounting points, with a being the sample thickness, b the sample width, and l the sample length

Slika 3. Načelo koje se primjenjuje za oblikovanje rezova na uzorku: 1 – rez koji se postupno povećava svakih 50 do 200 mm; 2 – položaj točaka ugradnje senzora, pri čemu je a debljina uzorka, b širina uzorka, a l duljina uzorka

After each incision increase, the amplitude-frequency characteristics of the specimens - the characteristic vibration modes - were determined in the 20-2000 Hz frequency range. In addition, the *MOE* and coefficient of damping were also calculated.

Specimens from subgroups 1.2, 2.2, and 3.2 were soaked in distilled water for about 170 hours and then dried at a temperature of 140 °C for twenty-four hours in order to force the formation of cracks (otherwise known as drying defects) due to excessive drying speed and the resultant stresses. After drying took place, the amplitude-frequency characteristics, characteristic vibration modes, *MOE*, and coefficient of damping of these specimens were also determined (Timoshenko *et al.*, 1985).

3 RESULTS AND DISCUSSION

3. REZULTATI I RASPRAVA

It was found that Group 1 specimens tend to vibrate at two resonant frequencies in the 20-2000 Hz frequency range. Vibrating at each of the frequencies, the specimens deflected in modes that were similar to the first and second modes for the theoretical isotropic beam (Timoshenko *et al.*, 1985). The amplitude-frequency characteristics and vibration modes of one of the specimens are presented in Figure 4.

For other Group 1 specimens, the analogous amplitude-frequency characteristics and similar vibration modes were both obtained.

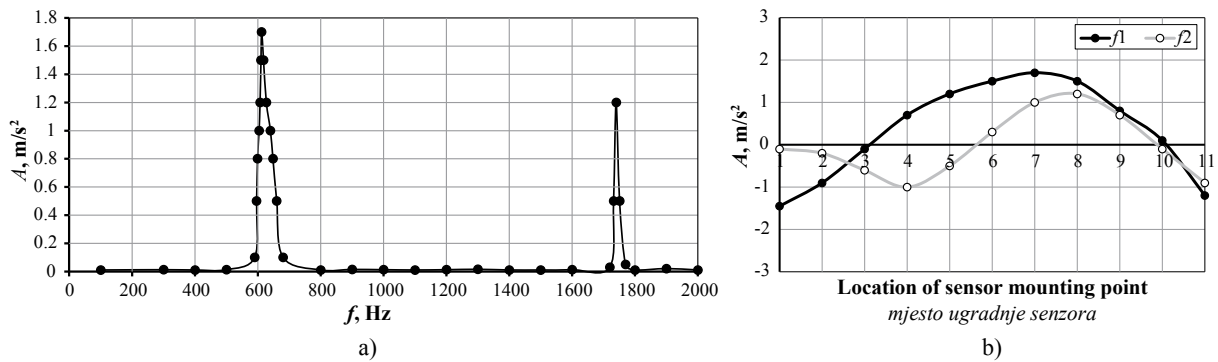

Figure 4 a) Amplitude-frequency characteristics, b) vibration modes for one of Group 1 samples close to the first and second modes of theoretical isotropic rod
Slika 4. a) Obilježja amplitude i frekvencije, b) načini vibracija za jedan od uzoraka grupe 1. koji su slični prvome i drugome modu teorijske izotropne šipke

In the case of groups 2 and 3, only one clear resonant frequency was recorded in the aforementioned frequency range. This can be explained by the fact that these specimens were thicker, and that their resonant frequency in the second mode was higher than 2000 Hz. Vibrating at these frequencies, the specimens deflected in modes that were similar to the first mode for the theoretical isotropic beam. The amplitude-frequency characteristics in the 20-2000 Hz frequency range and the vibration modes for one of the specimens in groups 2 and 3 are presented in Figure 5.

Other specimens in the above groups and 20-2000 Hz frequency range ‘behaved’ analogously. Later, using the theory for the theoretical isotropic beam, the MOE and coefficient of damping were calculated

analogously according to the determined resonant frequencies and other parameters for the specimens. The values are presented in Table 1.

Defects were then simulated in specimens from subgroups 1.1, 2.1, and 3.1. The parameters for the specimens - their resonant frequencies and their rating in the 20-2000 Hz frequency range, along with MOE and coefficient of damping - have changed after the incision has been made and increased. The characteristic change in the parameters for one of the samples in Subgroup 1.1 after making and increasing the incision is given in Table 2.

The amplitude-frequency characteristics for the above specimen in the absence of a defect, and when the length of any defect was 200 mm and the length of

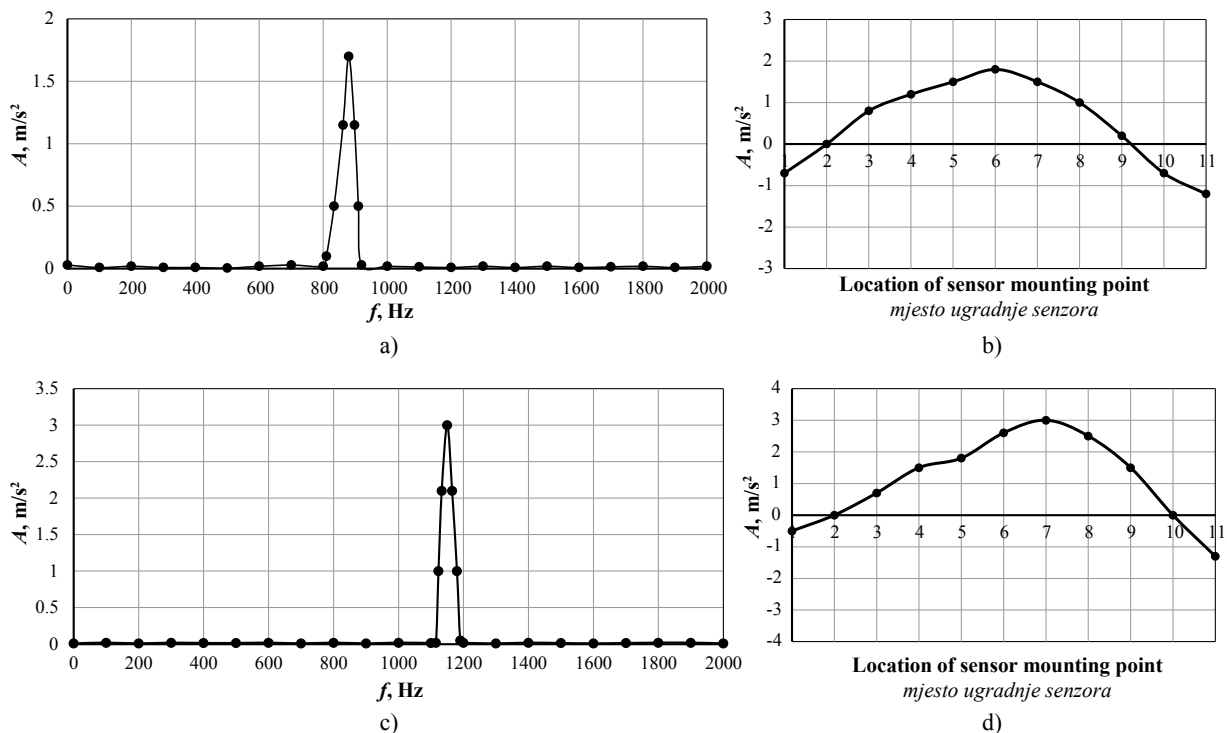

Figure 5 a) Amplitude-frequency characteristics and b) vibration mode of one of Group 2 samples, c) amplitude-frequency characteristics and d) vibration mode of one of Group 3 samples
Slika 5. a) Obilježja amplitude i frekvencije te b) način vibracije jednoga od uzoraka grupe 2.; c) obilježja amplitude i frekvencije te d) način vibracije jednoga od uzoraka grupe 3.

Table 1 Values for resonant frequencies, *MOE*, and coefficient of damping for each sample
Tablica 1. Vrijednosti rezonantne frekvencije, *MOE* i koeficijenta prigušenja za svaki uzorak

Sample group <i>Grupa uzoraka</i>	Resonant frequency, Hz <i>Rezonantna frekvencija, Hz</i>	Modulus of elasticity, MPa <i>Modul elastičnosti, MPa</i>	Coefficient of damping, r.u. <i>Koeficijent prigušenja, r.u.</i>
1	600-670, 1660-1745	14330-16525	0.017-0.020
2	840-915	11995-15845	0.018-0.021
3	1085-1205	10600 -14475	0.020-0.032

Note: Frequencies at which specimens deflected in a mode close to the second theoretical mode for isotropic beam are given in italics.
 Napomena: frekvencije napisane kurzivom jesu frekvencije pri kojima su uzorci skretali u mod sličan drugome teorijskom modu za izotropnu gredu.

Table 2 Variation in resonant frequencies, *MOE*, and coefficient of damping for one of the samples of Subgroup 1.1 with increasing incision length

Tablica 2. Varijacije rezonantnih frekvencija, modula elastičnosti i koeficijenta prigušenja za jedan od uzoraka podskupine 1.1. s povećanjem duljine reza

Length of incision, mm <i>Duljina reza, mm</i>	Resonant frequencies, Hz <i>Rezonantna frekvencija, Hz</i>	Modulus of elasticity, MPa <i>Modul elastičnosti, MPa</i>	Coefficient of damping, r.u. <i>Koeficijent prigušenja, r.u.</i>
0	615, 1670	14270	0.020
50	612, 1650	14130	0.021
100	600, 1620	13580	0.024
150	580, 1380, 1580	12690	0.025
200	571, 1290, 1566	12300	0.027

any defect in the form of vibration modes was 200 mm, are shown in Figure 6.

As is obvious, in the absence of a defect, the specimen vibrated at two resonant frequencies in the 20-2000 Hz frequency range. When the defect size reached 150 mm, a third resonant frequency appeared. Furthermore, the frequency in the ‘first mode’ significantly decreased when the incision length reached 150 mm in length. The shape of both the first and second modes became more complex and less similar to the theoretical mode for the isotropic beam as the defect developed (Figure 6, b).

Other specimens ‘behaved’ analogously during the defect simulation. It has been found that, after making and increasing the incision in the 20-2000 Hz frequency in all the specimens in Subgroup 1.1, the resonance frequency reading increased from two to between three and four, and from one to between two and three for subgroups 2.1 and 3.1. Furthermore, vibration-re-

lated modes became more complicated. This can be explained by the fact that the incision destroyed the solid body. The specimen became a more complex system consisting of several bodies when the incision reached a certain size. In most cases, more significant changes in mode were found when the incision length reached 150mm, equal to approximately a third of the entire specimen length. A solid beam-shaped body no longer existed, which means that it did not vibrate in a mode that could be analogous to the isotropic beam (Timoshenko *et al.*, 1985; Albrektas *et al.*, 2003).

According to the theory of vibration in isotropic beams (Timoshenko *et al.*, 1985), when a beam-shaped body vibrates, the amplitude of the vibrations is distributed according to specific patterns (for example, when the body vibrates in the ‘first mode’, the maximum amplitude is in the middle). This was observed until the incision length reached between 100-150mm. Then it became clear that, in some specimens, the reso-

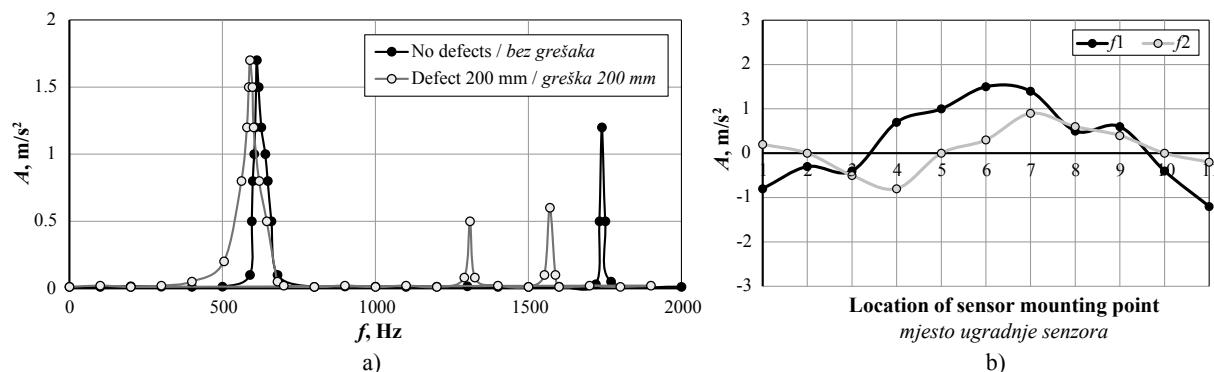

Figure 6 (a) Amplitude-frequency characteristics for one of the samples of Subgroup 1.1 with no defect and when the defect length is 200 mm, and (b) in the first and second mode of vibration when the defect length is 200 mm

Slika 6. (a) Obilježja amplitude i frekvencije za jedan od uzoraka podskupine 1.1. bez greške i uz duljinu greške 200 mm te (b) u prvome i drugom načinu vibracija pri duljini greške 200 mm

Table 3 Change of resonant frequencies, *MOE*, and coefficient of damping of specimens after forming a 200 mm incision
Tablica 3. Promjena rezonantnih frekvencija, modula elastičnosti i koeficijenta prigušenja uzoraka nakon formiranja reza od 200 mm

Specimen subgroup <i>Podskupina uzorka</i>	Resonant frequency, Hz <i>Rezonantna frekvencija, Hz</i>		Modulus of elasticity, MPa <i>Modul elastičnosti, MPa</i>		Coefficient of damping, r.u. <i>Koeficijent prigušenja, r.u.</i>	
	Without defect <i>Bez greške</i>	With defect <i>S greškom</i>	Without defect <i>Bez greške</i>	With defect <i>S greškom</i>	Without defect <i>Bez greške</i>	With defect <i>S greškom</i>
1.1	600-625 <i>1660-1745</i>	560-590 <i>1535-1570</i>	14330-16325	12330-14520	0.018-0.020	0.027-0.032
2.1	860-920	790-850	13515-15840	11260-13390	0.019-0.021	0.030-0.037
3.1	1125-1205	1035-1105	12525-14470	12125-10495	0.020-0.024	0.032-0.039

Note: The second (second mode) resonant frequency for samples in Subgroup 1.1 is given in italics.

Napomena: kurzivom je napisana druga rezonantna frekvencija (drugi način vibracija) za uzorke u podskupini 1.1.

nant frequencies of a body vibrating in the same mode and amplitudes differed significantly (by up to 4 %) at different sensor mounting locations (Figure 3) (in the absence of an incision, no such difference was observed). This can be explained by the fact that the specimen has already vibrated, not as a solid body but as a system of several bodies.

Changes in the parameters for the specimens after forming a 200 mm incision are given in Table 3.

The existing incision served to deteriorate the specimen mechanical properties (Oltean *et al.*, 2007; Albrektas *et al.*, 2003). It became apparent that, by making incisions which extended along half of the entire length of the samples, the resonant frequencies for the first

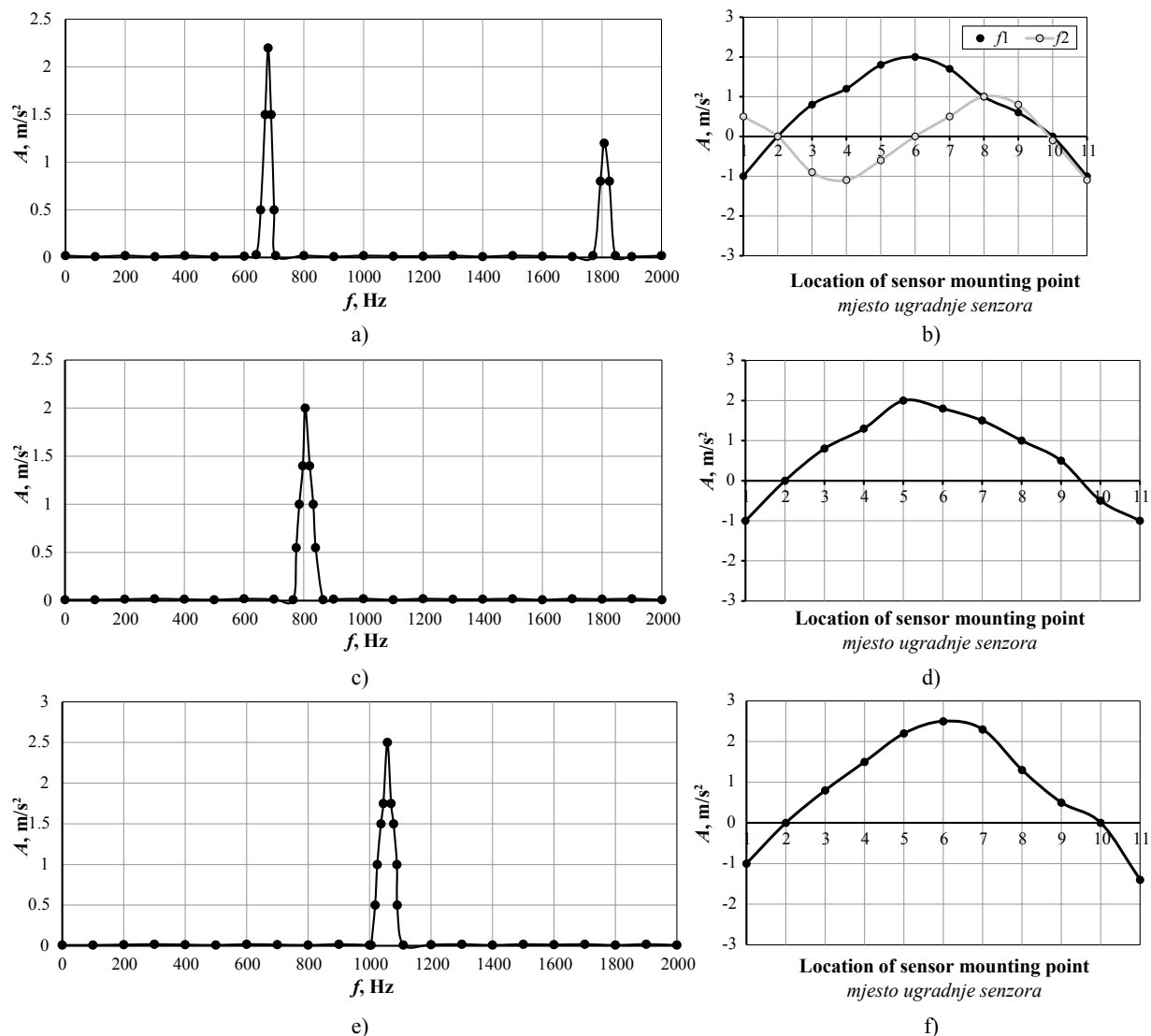

Figure 7 Amplitude-frequency characteristics (a, c, and e, respectively), and vibration modes (b, d, and f, respectively) for representative samples in subgroups 1.2, 2.2, and 3.2

Slika 7. Obilježja amplitude i frekvencije (a, c, e) te načini vibracija (b, d, f) za reprezentativne uzorke u podskupinama 1.2., 2.2. i 3.2.

mode in the thinnest specimens tended to decrease by 6 % on average, and in the medium thickness and the thickest specimens this figure increased to about 8 %. The average *MOE* decreased by 12.5 %, 16.0 %, and 16.2 %, respectively, while the average damping ratio increased by 60 %, 70 %, and 64 %, respectively.

Similarly, specimens in subgroups 1.2, 2.2, and 3.2 were tested in the 20-2000 Hz frequency range. The amplitude-frequency characteristics and vibration modes of a representative specimen of each subgroup are shown in Figure 7.

In the above frequency range, analogous to the specimens in subgroups 1.1, 2.1, and 3.1, two resonant frequencies were observed for the thinnest specimens (these specimens tended to vibrate in the first and second mode in a way similar to that of the theoretical isotropic rod vibration modes). For thicker specimens,

one resonant frequency was observed for each specimen, vibrating at a rate at which they deflected in modes that were similar to the first mode for the theoretical isotropic beam. The specimens were then soaked and dried to force high stresses and form significant drying defects (internal cracks). The amplitude-frequency characteristics and vibration modes for the specimens, which were determined following the drying process, are presented in Figure 8.

Specimens from Subgroup 1.2 vibrated at two resonant frequencies in the 20-2000 Hz frequency range prior to forming any drying defects. Following the formation of such defects, the resonant frequencies increased to between three and four. In all specimens from subgroups 2.2 and 3.2, one resonant frequency was observed in each of them prior to the appearance of any defect formation, and in two to three frequencies

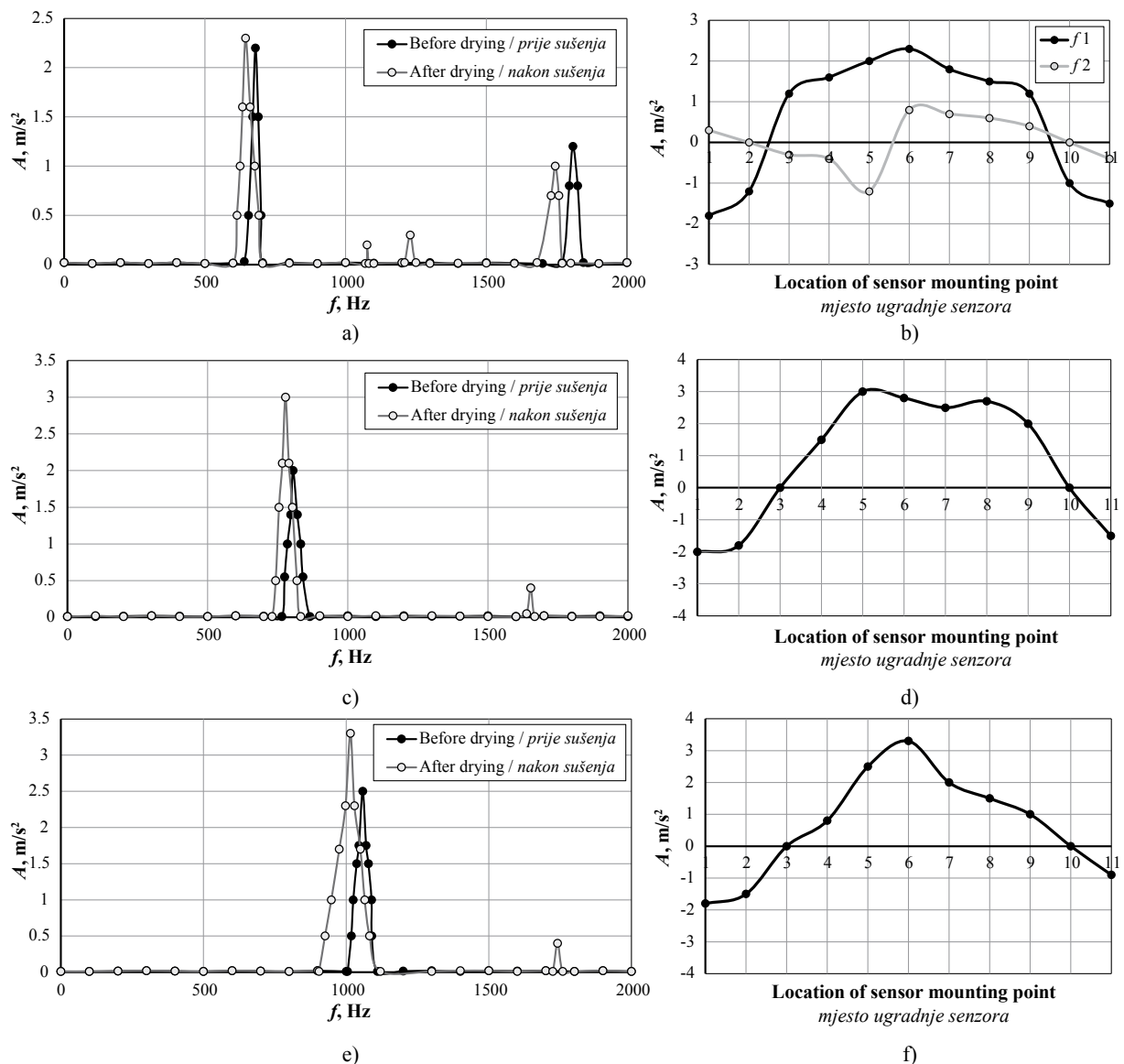

Figure 8 Amplitude-frequency characteristics for representative samples in subgroups 1.2, 2.2, and 3.2 before and after drying (a, c, and e, respectively), and vibration modes after drying (b, d, and f, respectively)

Slika 8. Obilježja amplitude i frekvencije za reprezentativne uzorke u podskupinama 1.2., 2.2. i 3.2. prije i nakon sušenja (a, c, e), te načini vibracija nakon sušenja uzoraka (b, d, f)

Table 4 Change in resonant frequencies, *MOE*, and coefficient of damping of samples following the formation of drying defects
Tablica 4. Promjena rezonantnih frekvencija, modula elastičnosti i koeficijenta prigušenja uzoraka nakon nastanka grešaka sušenja

Specimen subgroup <i>Podgrupa uzorka</i>	Resonant frequency, Hz <i>Rezonantna frekvencija, Hz</i>		Modulus of elasticity, MPa <i>Modul elastičnosti, MPa</i>		Coefficient of damping, r.u. <i>Koeficijent prigušenja, r.u.</i>	
	Without defect <i>Bez greške</i>	With defect <i>S greškom</i>	Without defect <i>Bez greške</i>	With defect <i>S greškom</i>	Without defect <i>Bez greške</i>	With defect <i>S greškom</i>
1.2	635-665	605-635	14480-16520	11500-13800	0.017-0.020	0.021-0.025
2.2	840-905	815-900	11990-15440	11075-14530	0.018-0.020	0.023-0.031
3.2	1085-1145	1005-1130	10600-12385	9100-11780	0.021-0.032	0.026-0.036



Figure 9 Characteristic defects after extreme drying and/or thermal modification
Slika 9. Karakteristične greške nakon intenzivnog sušenja i/ili toplinske modifikacije

following the appearance of defects. This can be explained by the fact that the specimen became a system of individual bodies, as in the case of an incision.

Changes in the mechanical properties of specimens from the above subgroups due to drying defects are presented in Table 4.

Photographs revealing the characteristic defects formed during the phase of extreme drying are shown in Figure 9.

It was found that there were significant changes in the mechanical properties of the samples with the formation of drying defects, as was also true in the case of making the initial incision. The resonant frequency of the thinnest specimens, when they deflect in a mode similar to that of the first mode for the isotropic beam, tended to decrease by an average of about 4.6 %, with their *MOE* decreasing by an average of 18.4 %, and the coefficient of damping increasing by about 21 %. Accordingly, the average resonant frequency for medium-thickness specimens tended to decrease by about 1.7 %, the *MOE* decreased by an average of 6.7 %, and the coefficient of damping increased by 42 %. The frequency of the thickest specimens decreased by an average of 4.2 %, while the *MOE* decreased by an average of 9.2 %, and the coefficient of damping increased by 13 %.

All of the data obtained from the tests had to be statistically processed. It was found that the coefficient of variation for the *MOE* values for those specimens in the subgroups that had no defects changed from a reading of 3.87 % to one of 5.30 %, while the coefficient of damping changed from 4.71 % to 6.19 %. After forming a single defect (making an incision) with a length of 200 mm, these values fell within the

limits of 4.81-6.00 % and 5.15-6.57 %, respectively. The most significant scatter of values for the mechanical properties could be observed in the sample subgroups where drying defects were observed. The variation coefficient for values in terms of the *MOE* changed within limits that fell between 6.38-9.72 %, while the coefficient of damping changed within the range of 7.99-9.37 %.

The analysis of results obtained shows that the above drying defects had a similar effect on the mechanical properties of the specimens, as did the 200 mm incision. This can be explained by the fact that the defects (cracks) were formed along with the wood fibre and were sufficiently significant. On the other hand, the incision had a more uniform effect on the mechanical properties of all specimens, regardless of their dimensions, fibre arrangement, etc. Drying defects were formed in various ways, with their eventual size and location differing from one other. The higher scattering of mechanical properties obtained following the completion of the drying process is also shown in the statistics. In addition, the smallest scatter of values could be found in subgroups that included the thinnest assortments. This is most likely due to the fact that, as the volume of the specimen decreases, the specimens become less 'anisotropic'.

4 CONCLUSIONS

4. ZAKLJUČAK

It was found that a defect that amounts to a quarter or more of the entire length of a specimen can significantly change its amplitude-frequency characteristics.

The number of resonant frequencies increases within the same frequency range, while the characteristic (resonant) vibrations decrease. The emerging 'new' frequencies do not correspond to the first, second, or later specimen mode frequencies. The detection of such frequencies is the simplest way to detect a defect in a specimen.

It was found that a defect that amounts to a quarter or more of the entire length of a specimen clearly replaces the first and second modes for the beam-shaped specimen, which, in the absence of any defect, corresponds to the vibration modes for the theoretical isotropic beam. The defect destroys the beam-shaped specimen, as a solid body, breaking it into a multi-mass system. As a result, the vibration modes for such a specimen are no longer similar to the vibration modes for the theoretical isotropic beam, and the resonant frequency may differ more significantly (by up to 4 %) in different specimen areas.

It was also found that a defect that amounts to at least 12.5 % of the entire length of a specimen can reduce the *MOE*, while increasing the coefficient of damping. As the defect increases, the *MOE* decreases even more, while the coefficient of damping increases (when the defect reaches half the entire length of the specimen, the *MOE* may decrease to 20 % of the total, while the coefficient of damping may increase to 80 %).

It was found that, due to wood anisotropy, any drying defects are formed differently in that wood, exhibiting a different effect on the *MOE* and coefficient of damping for the wood. This is indicated by the increased scatter of the values for these parameters in the presence of such defects.

It has been shown that the method used based on transverse resonant vibrations can detect and evaluate invisible drying and other wood defects.

5 REFERENCES

5. LITERATURA

1. Albrektas, D.; Vobolis, J., 2003: Investigation of mechanical parameters and defects of solid wood glued panels. *Materials Science*, 9 (4): 368-373.
2. Broch, J. T., 1984: *Mechanical Vibrations and Shock Measurements*. Grostrum. K. Larsen and Son, pp. 370.
3. Dietsch, P., 2017: Effect of reinforcement on shrinkage stresses in timber members. *Construction and Building Materials*, 150: 903-915. <https://doi.org/10.1016/j.conbuildmat.2017.06.033>
4. Hamdi, S. E.; Pitt, R. M.; Dubois, F., 2016: Temperature variation effect on crack growth in orthotropic medium: Finite element formulation for the viscoelastic behavior

- in thermal cracked wood-based materials. *International Journal of Solids and Structures*, 115-116: 1-13. <https://doi.org/10.1016/j.ijsolstr.2016.09.019>
5. Hossein, M. A.; Shahverdi, M.; Roogna, M., 2011: The effect of wood knot as a defect on modulus of elasticity (*MOE*) and damping correlation. *Notulae Scientiae Biologicae*, 3 (3): 145-149. <https://doi.org/10.15835/nsb336119>
6. Kamal, K.; Qayyum, R.; Mathavan, S.; Zafar, T., 2017: Wood defects classification using laws texture energy measures and supervised learning approach. *Advanced Engineering Informatics*, 34: 125-135. <https://doi.org/10.1016/j.aei.2017.09.007>
7. Karabagli, A.; Mougel, E.; Chrusciel, L.; Zoulalian, A., 1997: Study on a low temperature convective wood drier of some operating parameters on drier modelling and on the quality of dried wood. *Holz als Roh- und Werkstoff*, 55: 221-226.
8. Oltean, L.; Teischinger, A.; Hasmann, Ch., 2007: Influence of temperature on cracking and mechanical properties of wood during wood drying – a review. *BioResources*, 2 (4): 789-811.
9. Perlsaksson, J. C., 2018: Dynamic crack propagation in wood fibre composites analysed by high speed photography and a dynamic phase field model. *International Journal of Solids and Structures*, 144-145: 78-85. <https://doi.org/10.1016/j.ijsolstr.2018.04.015>
10. Perré, P.; Passard, J., 2004: A physical and mechanical model able to predict the stress field in wood over a wide range of drying conditions. *Drying Technology*, 22 (1-2): 27-44. <https://doi.org/10.1081/DRT-120028202>
11. Poncsak, S.; Kocaefe, D.; Bouazara, M.; Pichette, A., 2006: Effect of high temperature treatment on the mechanical properties of birch (*Betula papyrifera*). *Wood Science and Technology*, 40: 647-663. <https://doi.org/10.1007/s00226-006-0082-9>
12. Timoshenko, S.; Young, D. H.; Weaver, W. jr., 1985: *Vibration problems in engineering*. Moscow. Mashinostroyeniye, pp. 472.
13. Vobolis, J.; Albrektas, D., 2013: Resonant vibration-based evaluation of wood drying defects. *Journal of Measurements in Engineering*, 1 (2): 113-120.
14. Wang, X.; Ross, R. J.; McClellan, M.; Barbour, R. J.; Erickson, J. R.; Forsman, J. W., 2000: *Strength and stiffness assessment of standing trees using a non destructive stress wave technique*. Madison: U.S. Department of Agriculture.
15. ***Forest Products Laboratory, 2010: *Wood handbook – Wood as an engineering material*. General Technical Report FPL-GTR-190. Madison, WI: U.S. Department of Agriculture, Forest Service, Forest Products Laboratory, pp. 508.
16. ***Standard LST EN 13183-2:2003 *Moisture content of a piece of sawn timber. Part 2: Estimation by electrical resistance method*.
17. ***Standard LST EN 323:1999. *Wood-based panels – Determination of density*.

Corresponding address:

Assoc. Prof. DARIUS ALBREKTAS, PhD

Kaunas University of Applied Sciences, Faculty of Technology, Pramonės pr. 20, LT – 50468 Kaunas, LITHUANIA, e-mail: Darius.Albrektas@ktu.lt